



www.maco.eu

AUSTRIAN LIVING COMFORT

NEW WAYS TO DESIGN, SECURITY & COMFORT



WE SHOW YOU NEW WAYS TO

DESIGN
SECURITY
COMFORT



EDITORIAL

WE SHAPE LIVING ENVIRON- MENTS

Together with you. Thanks to the excellent collaboration with our partners, we are able to keep a close eye on the market. We adapt our products to suit customer requirements, not vice-versa. This means we translate people's specific needs into innovations which make their everyday lives easier. We offer intelligent, contemporary solutions, and in doing so, we look beyond our hardware products and take the entire system into account.

Hence topics such as barrier-free access, operating comfort, security and even design become increasingly important. Topics which are encapsulated in our motto of **Austrian living comfort**. We supply quality from Austria which you can rely on.

This makes us a trendsetter and allows you to set yourself apart from your competitors thanks to a comprehensive portfolio and higher level of service.

Take a look at the following pages where our clever complete solutions speak for themselves or get in touch with us directly. We look forward to talking with you.

NEW APPROACHES TO DESIGN, SECURITY & COMFORT

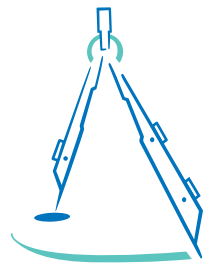

DESIGN

Modern architecture is defined by clean lines and the absence of superfluous elements. Flush, concealed hardware and ever narrower frames are MACO's response to these requirements. As our hardware can accommodate enormous sash weights, any large-format glazing required by current residential architecture can be created.

Our clever products overcome design-based, heavy-weight challenges and make it possible to create units which offer incredible functionality. Our hardware portfolio provides you with complete flexibility when it comes to design – enabling a variety of window shapes, opening types, combination possibilities and additional functions to be realised.

Our products don't just complete windows, doors and sliding units, they shape living environments. The key aspects here are design, security and comfort. Three topics which have always been of great importance at MACO. They are the key to Austrian living comfort and the MACO product promise, which is reflected in aspects such as easy operation, intelligent functionality, simple installation and maintenance as well as innovative security.



SECURITY

The tried-and-tested MACO i.S. security roller cam, new products such as the secure tilt position and the RC 3 timber system test for all hinge-sides are all examples of how MACO is continually setting benchmarks in terms of mechanical burglary resistance. Be inspired by our new and unique, self-locking drive gear or our modern, high-security access management system, for example.

For us, however, security is more than burglary resistance. We also take protection against extreme weather phenomena into consideration: a special flood protection setup protects residents against these dangers.



COMFORT

Windows which keep the heat in and thereby keep energy costs down. Large-format units which, despite their huge dimensions and heavy weights, can be slid open with ease and, during locking, are drawn back towards the frame as if they are acting by themselves. Barrier-free casement doors which allow everyone to pass through unhindered. Doors which can be conveniently unbolted using a smartphone app or a car key and then open automatically.

Have a browse through the following pages and discover these and many more user-oriented solutions, which you can realise with our products.

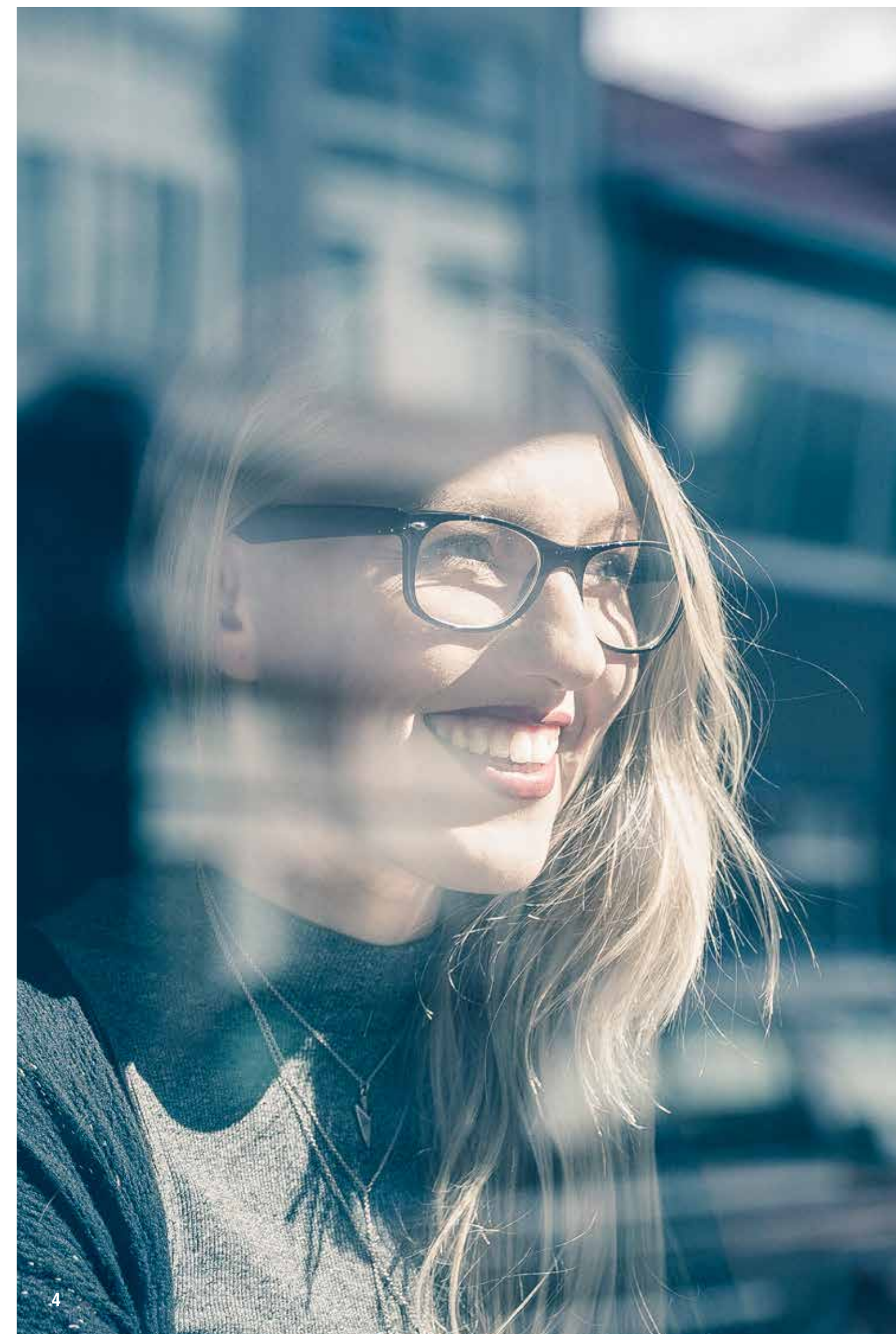

CONTENTS



MACO. TECHNOLOGY IN MOTION

1



AUSTRIAN LIVING COMFORT

8

100% MADE IN AUSTRIA

10

EXPERTISE

12

THE MACO GROUP

16

AUSTRIAN QUALITY WORLDWIDE

18

SERVICES

22

QUALITY

28



WINDOWS

30

MULTI POWER

32

MULTI MAMMUT

34

DT160

36

SECURITY SOLUTIONS

38

COMFORT SOLUTIONS

46

ESPAGS

48

EMOTION

50

VENT

52



DOORS

54

OPENLIFE

56

G-TA

58

Z-TA

60

C-TS

62

Z-TM

64

PRO-DOOR T100R

66



DOUBLE HUNG SASHES

68

PANORAMA SYSTEM

70

PVC SYSTEMS

74

PARALLEL-STOP SLIDE HARDWARE

78

STANDARD-COMPLIANT BUILDING CONNECTION

84



MACO. THE KEY TO YOUR SUCCESS

OUR COMMITMENT

- COMPETENT
- INNOVATIVE
- CREATIVE
- GOAL-ORIENTED
- EFFICIENT
- SERVICE-ORIENTED

FULL OF IDEAS

Innovative strength is the most important factor for our success. We identify your market requirements, develop practice-oriented product solutions and keep you ahead of the competition. The functionality and quality of our hardware and solutions secure your future.

COLLABORATIVE

We actively seek out dialogue with you – our customers. Reliable and expert advice is the key to our mutual success. Let our complete solutions increase your competitive ability. Our motto is technology in motion with quality that speaks to you and your end customers.

CUSTOMER-SPECIFIC

We work with you to craft bespoke solutions that you can easily integrate into your company's infrastructure and production. We invest in product development that gives you a distinctive image. Our complete solutions consist of product, advice and active support for your marketing efforts.

MACO, family owned company based in Salzburg, has dedicated itself to this principal for nearly 70 years. After all, only our products – high-tech, high-performance hardware – make windows, doors, and lift&slide units safer, more energy-efficient and more user-friendly. And by doing so, they play a significant role in **making your customers' lives more comfortable.**

TECHNOLOGY IN MOTION



AUSTRIAN LIVING COMFORT





100% MADE IN AUSTRIA



OUR RECIPE FOR SUCCESS

100% made in Austria, sold in over 40 countries worldwide. Austrian precision ensures the high quality of our products and services around the world. And not just in construction and development, but also in production and manufacturing.



THE HARDWARE PROFESSIONAL

Our Austrian production location offers an unparalleled level of in-house production. Coupled with our unique service expertise and strong track record in implementation, we make an effective, high-performance partner.



EVERYTHING FROM A SINGLE SOURCE

MACO is a hardware manufacturer with a high level of market continuity and stability. Since over 98% of our production takes place in-house, we are able to respond quickly and flexibly to market changes or customer requirements, even at short notice. As a full-service provider, we provide a wide range of hardware solutions for your product lines – all from a single source.



RELY ON OUR EXPERTISE!

QUALITY GUARANTEES

- CERTIFIED SUPPLIERS
- SELECTED MATERIALS
- STATE-OF-THE-ART 3D MEASUREMENT METHODS
- COMPREHENSIVE SERIES MONITORING
- CERTIFIED STANDARD TESTS

QUALITY

MACO stands for consistent quality in terms of the function and finish of its products. This is confirmed by continuous benchmarking. The premium provider only works with certified suppliers and utilises pre-tested, selected materials.

Intelligent product design, advanced manufacturing and testing methods as well as competent, dedicated employees ensure consistently high quality. By offering a top apprenticeship program, which MACO has been running for years, the company is investing in its human capital and securing long-term expertise and the necessary skilled workers. In turn, this guarantees top quality production processes and products for you.



SUSTAINABILITY

We work in accordance with economic, environmental and social aspects. In doing so, we pave the way for the sustainable corporate success of our customers and the MACO Group. We have been a member of the German Sustainable Building Council (DGNB) since January 2013. MACO is a Climate Alliance enterprise. All production locations and the production of the hardware itself comply with the regulations for conservation of resources and energy conservation, as well as environmental protection.

CLEAR STRENGTHS

- 98 PERCENT OF OUR PRODUCTION TAKES PLACE IN-HOUSE
- SELF-DEVELOPED PRODUCTION LINES
- A LEADER IN INJECTION MOULDING TECHNOLOGY
- A SPECIALIST IN MECHANICAL BURGLARY RESISTANCE
- SURFACE TECHNOLOGY IS A KEY AREA OF EXPERTISE

SEVEN SURFACE PROCESSING TECHNOLOGIES

- EXTREMELY CORROSION-RESISTANT TRICOAT-PLUS
- SILVER LOOK (ELECTRO-PLATING)
- RUSTICO-PREMIUM (POWDER COATING)
- ANODIZING
- WET VARNISHING
- VACUUM EVAPORATION
- PVC COATING

TECHNOLOGY

We continually develop our manufacturing technology and adapt it to meet customer requirements. Not only do we manufacture all the tools ourselves, a large proportion of the systems and assembly lines are also individually designed, constructed and built by us to meet current and future needs; sometimes in collaboration with long-standing partners. This means that the company possesses technical expertise and guarantees short paths and fast response times. A real benefit for our customers.

SECURITY

Burglar resistance is one of the key functional requirements of windows and doors. The longer a building element can thwart a burglary attempt, the safer an apartment or house is and the more secure its residents will feel. When it comes to security, mechanical burglary resistance is key. MACO specialises in the development and production of burglar-resistant hardware.

SURFACE FINISH

Surface treatment which offers maximum corrosion protection is one of the key technologies in the company. Seven surface processing technologies are used in our in-house production – from anodising and powder coating to the TRICOAT-PLUS surface finish. This unparalleled surface processing technology is far superior to cold galvanised hardware with regard to corrosion. MACO offers the industry's widest range of surfaces produced in-house.

DEVELOPMENT & INNOVATION

As a technology leader, MACO has always developed benefit-based product solutions. They make an impact with innovative technology, the ultimate in quality and design-oriented functionality. We don't just monitor trends. We are a trendsetter for the building hardware of the future. During product development, current function and design requirements are incorporated into our intelligent hardware solutions.

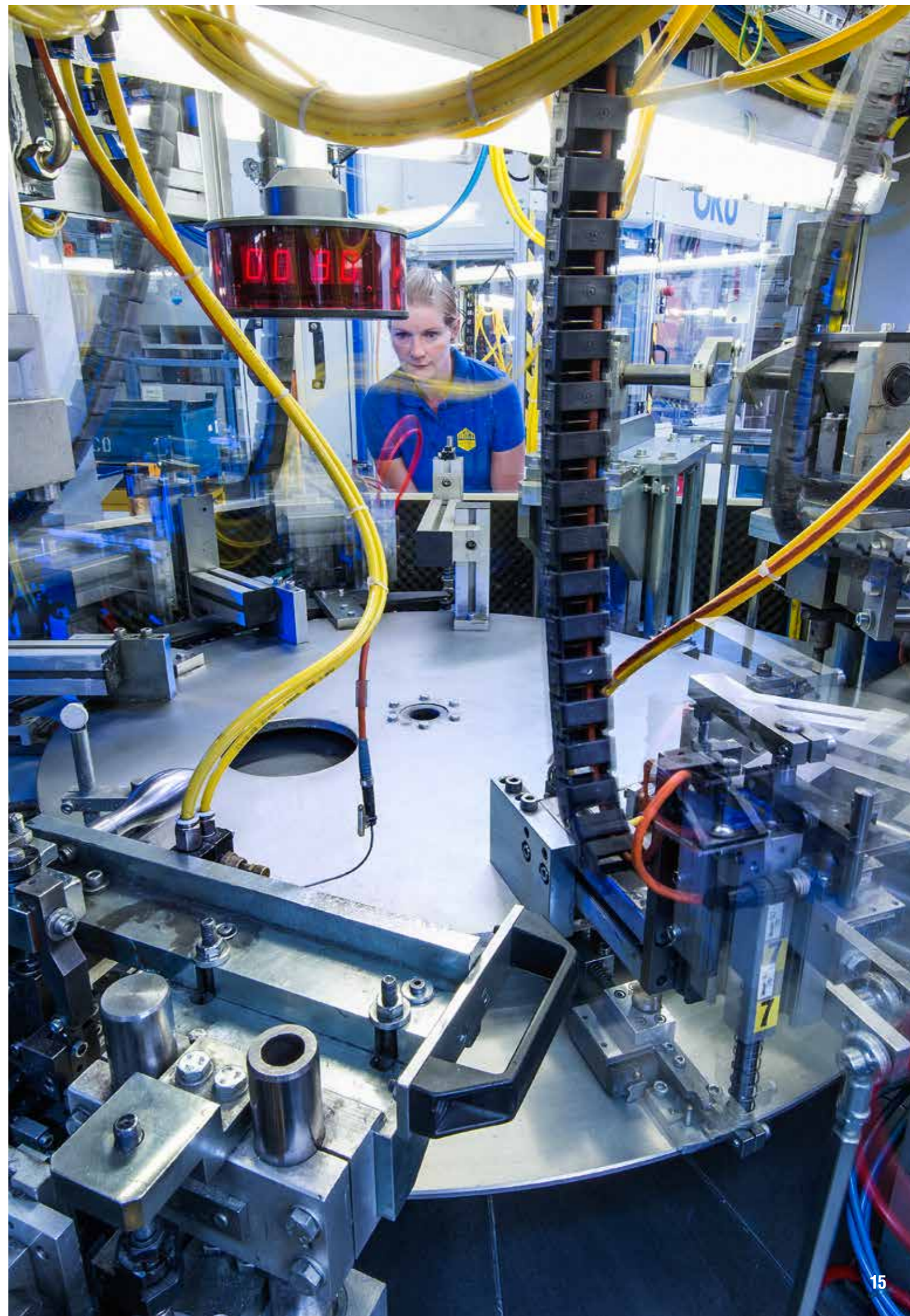

01 MACO HEADQUARTERS AND PRODUCTION PLANT
SALZBURG, AUSTRIA

02 MACO PRODUCTION PLANT
MAUTERNDORF, AUSTRIA

03 MACO PRODUCTION PLANT
TRIEBEN, AUSTRIA

04 MACO ASSEMBLY PLANT
KALUGA, RUSSIA



THE PATH TO SUCCESS

TRADITION AND VISION

MACO was founded in 1947 with 18 employees and over the course of almost 70 years, the company has developed into one of the global leaders for window and door fittings. Approximately 2,000 people are employed in all departments, ranging from development through to sales.

With an export rate of 96%, the company sells its products in over 40 markets worldwide, with a focus on Europe.

NUMBERS. DATA. FACTS. MACO ON ONE SIGHT

1947 FOUNDED

3 AUSTRIAN PRODUCTION PLANTS

15 INTERNATIONAL SUBSIDIARIES

1 ASSEMBLY PLANT IN RUSSIA

2,000 EMPLOYEES WORLDWIDE

40 MARKETS AROUND THE WORLD

98% OF PRODUCTION TAKES PLACE IN-HOUSE



MACO. AUSTRIAN QUALITY WORLDWIDE



MACO REFERENCES



01 **PROJECT** VILLA AIELLO
LOCATION RENDE, COSENZA, ITALY

02 **PROJECT** VILLA ROYAL - ORCHID EILAT HOTEL
LOCATION EILAT, ISRAEL

03 **PROJECT** HAUS RIEGEL
LOCATION BILDSTEIN, AUSTRIA

04 **PROJECT** VILLA ARENA
LOCATION RENDE, COSENZA, ITALY

05 **PROJECT** ILLWERKE ZENTRUM MONTAFON
LOCATION VANDANS, AUSTRIA

AT HOME AROUND THE WORLD

Millions of windows, doors and sliding units are equipped with MACO products each year. This is a testimony of our high quality, which is appreciated by customers around the world.



01



02



03



04

01 **PROJECT** "KOPERNIK" RESIDENTIAL COMPLEX
LOCATION MOSCOW, RUSSIA

02 **PROJECT** RESIDENTIAL HOUSE
LOCATION SOUTH YARRA, MELBOURNE, AUSTRALIA

03 **PROJECT** EUROPA GALERIE
LOCATION SAARBRÜCKEN, GERMANY

04 **PROJECT** VILLA AIELLO
LOCATION RENDE, COSENZA, ITALY

05 **PROJECT** RESIDENTIAL HOUSE
LOCATION SOUTH YARRA, MELBOURNE, AUSTRALIA

FOCUS ON CUSTOMERS

Building hardware translated into impressive user benefits – MACO has embraced this guiding principle for almost 70 years. The years of experience, assured quality and outstanding solution expertise make MACO a strong and reliable business partner.

05





JUST FOR YOU: OUR SERVICES

Reputable and expert advice ensures the mutual success of partnerships. Our advice is centred on your sustainable growth. We develop solutions for and together with you, our customers, that enable us both to excel in the market and that can be individually adjusted to suit your infrastructure and production options. We focus on you.

CUSTOMER PORTAL

All customer-specific and technical information and documents are collected in the "extranet" customer portal, where they can be accessed at any time. The extranet is an exclusive, password-protected area which can only be accessed by registered users (customers and business partners).

ORDER PLATFORM

The integrated order platform is the simplest and quickest way to send us your order requests. Shopping basket templates, a complete overview of all your orders, invoices and delivery notes as well as useful search functions all help to make ordering a breeze.

TEST CENTRE

MACO is a partner and external partner agency of the accredited testing and inspection body gbd LAB GmbH. Customer tests for joint and watertightness along with additional tests for burglary resistance are carried out at our test centre in Salzburg and documented with an internationally valid test certificate. This means you can easily meet your CE marking obligation.



COMPREHENSIVELY TESTED
AS A MACO CUSTOMER YOU
CAN USE OUR OBTAINED TEST
CERTIFICATES UNDER LICENCE –
SAVING YOU EFFORT AND MONEY.

TOM – TECHNICAL ONLINE CATALOGUE MACO

If catalogues for building hardware seem more like an impenetrable jungle, then give TOM a try. As part of the customer portal, this interactive platform provides access to full technical information and notes for correct processing of the hardware.

This includes item tables, data sheets, drawings, clickable hardware combinations and even market-dependent price indications. As a finishing touch, you can even order the desired item directly via the order platform.

MAINTAIN AN OVERVIEW

ALL TECHNICAL INFORMATION AND NOTES FOR CORRECT PROCESSING OF THE HARDWARE ARE AVAILABLE IN TOM.

HARDWARE CALCULATION PROGRAM

In just a few steps, MACOWin 2.0 generates a complete parts list of the hardware components that you need for your quotations and calculations. All you need to do is select the type of window and enter the sash rebate dimensions. The generated parts lists can be adapted at any time. Thanks to the link to TOM, you are also given the relevant technical information for each item for easy processing.

TOM OFFLINE APP

With our prize-winning app for Windows, you always have all TOM data to hand, even when you are not working on a UMTS or WLAN network. This data can then be updated when an internet connection is available.

Originally designed purely for internal MACO use, the level of customer interest has also prompted us to make the TOM offline app available to you, our customers. Key features are the search by barcode scan function and optional, intuitive touch operation.

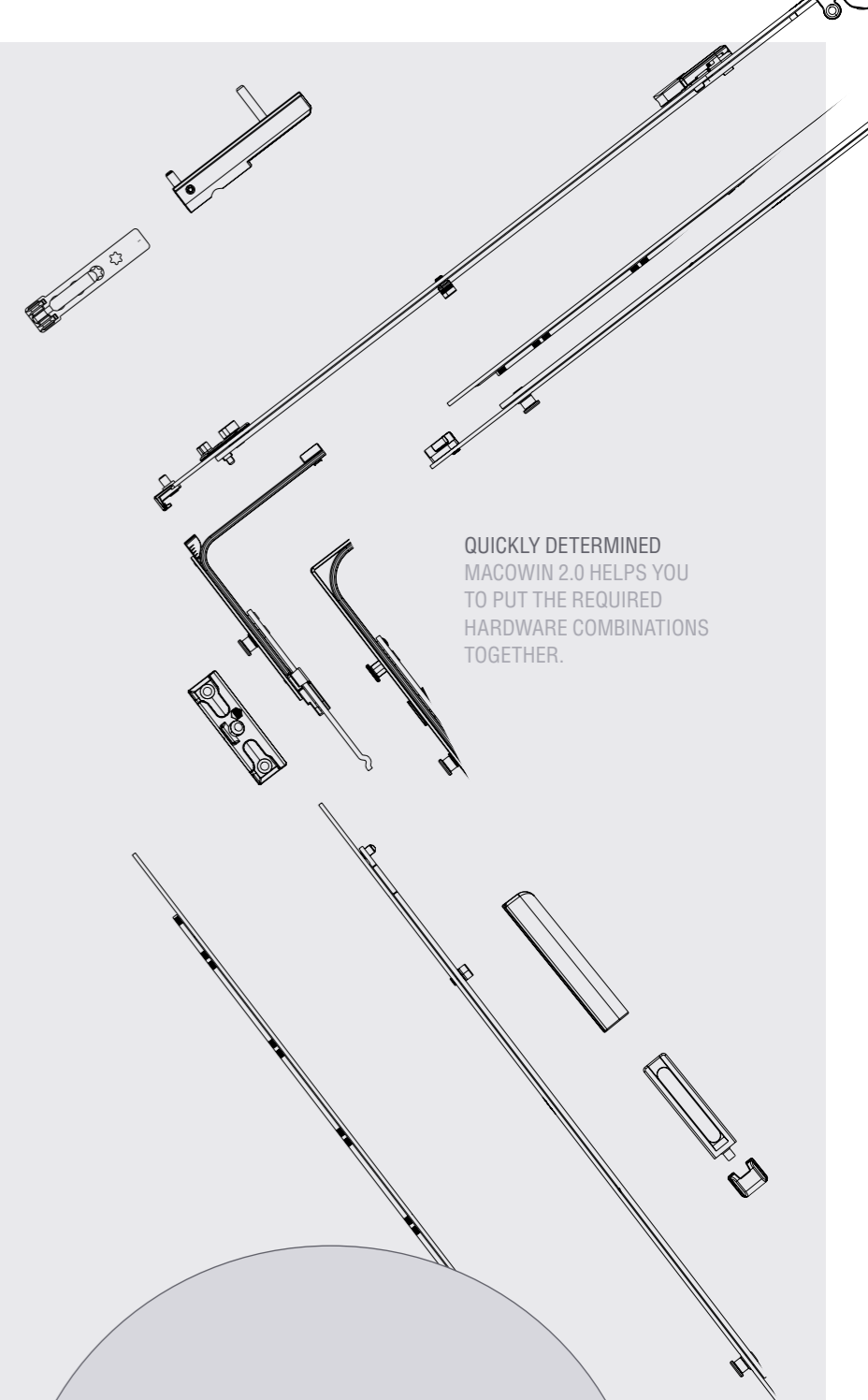

QUICKLY DETERMINED
MACOWIN 2.0 HELPS YOU
TO PUT THE REQUIRED
HARDWARE COMBINATIONS
TOGETHER.



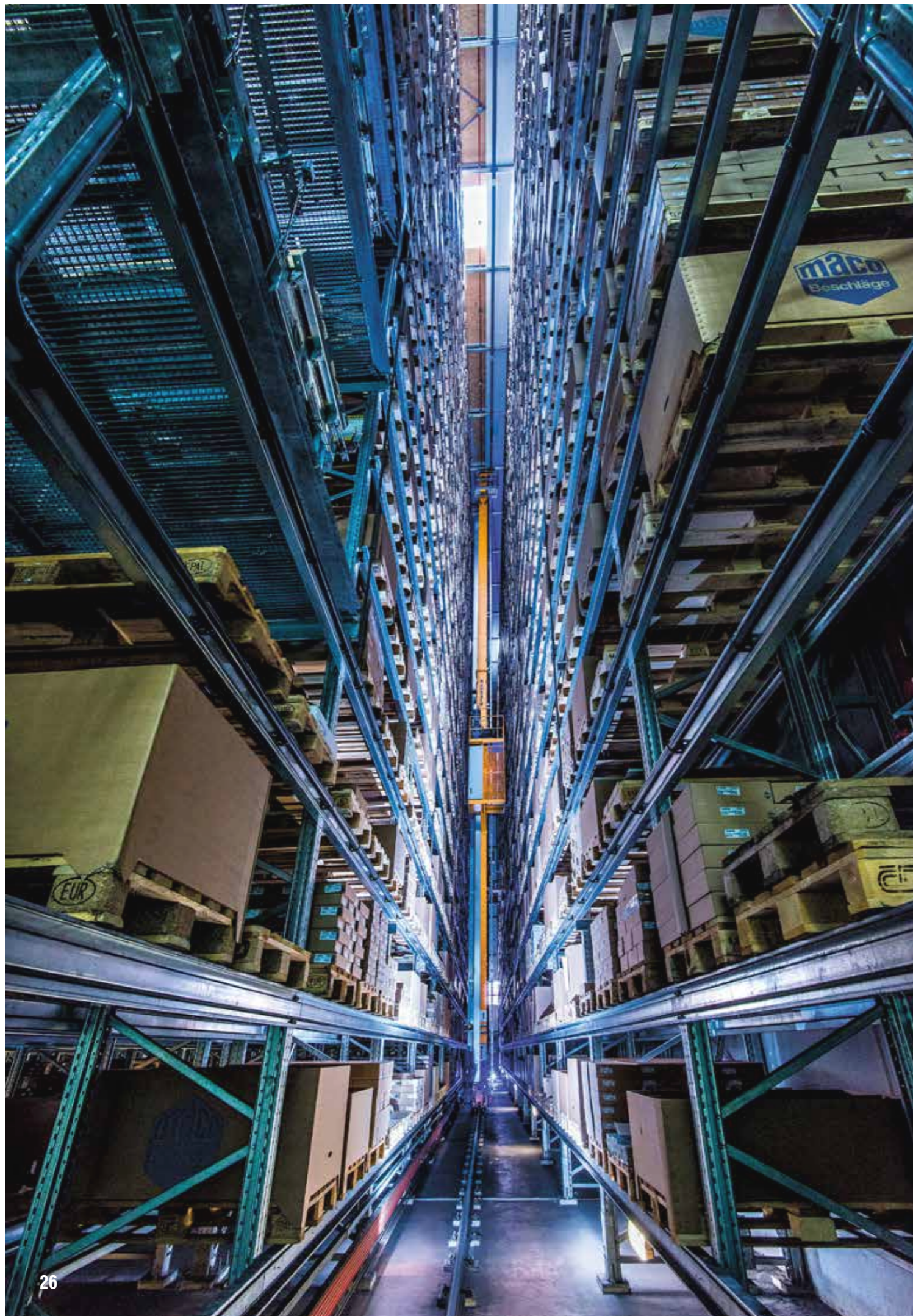

THE MACO SUPPLY CHAIN
WITH PERFECTLY COORDINATED
PROCESSES, WE GUARANTEE A HIGH
LEVEL OF QUALITY AND RELIABLE
DELIVERY.

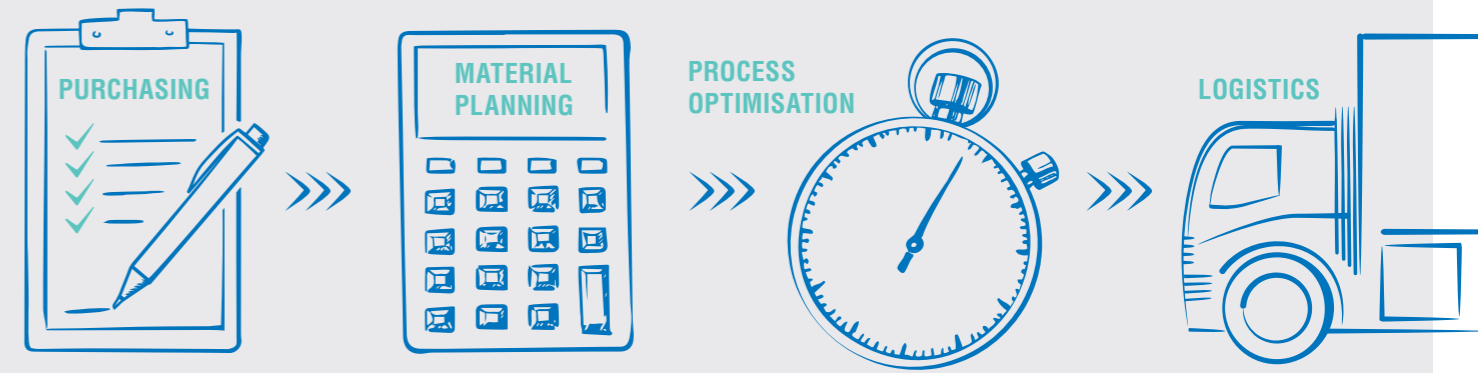

LOGISTICS

A group-wide, integrated supply chain process guarantees optimum supply for our Trieben logistics centre and the regional warehouses at six of our 15 international sales subsidiaries. This and our global sales and distribution network ensure quick

and timely delivery throughout Europe and worldwide. At MACO, you know your contact partner. This is because our emphasis on personal contact reflects our commitment to our customers.

TOP QUALITY? GUARANTEED AT MACO!



PERFORMANCE GUARANTEE

We feel confident about the outstanding and reliable product quality of our hardware solutions. That is why we provide a performance guarantee of 10 years for the main product groups MULTI turn-only and turn&tilt hardware, RAIL SYSTEMS sliding hardware and PROTECT door locks and 12 years for our EMOTION window handles. This means that you too can rest assured that you are offering your customers only the very best quality.



SERVICEABILITY

We know that our production processes and products are of high quality, but we also have this externally verified on an ongoing basis:

- MULTI TURN-ONLY AND T&T HARDWARE ACCORDING TO QM 328 AND RAL-GZ 607/3
- RAIL-SYSTEMS LIFT&SLIDE HARDWARE ACCORDING TO QM 346
- RAIL-SYSTEMS SLIDE&TILT HARDWARE ACCORDING TO QM 347
- PROTECT DOOR LOCKS ACCORDING TO QM 342
- EMOTION WINDOW HANDLES ACCORDING TO RAL-GZ 607/9



CORROSION PROTECTION

Top protection against salts, acids and alkalis, aggressive cleaning agents and builder's dust – with guaranteed corrosion protection for the TRICOAT-PLUS surface protection developed by MACO. There's no contender for coastal regions, industrially congested areas, indoor swimming pools and livestock stables; as well as when processing highly tannic types of timber – incl. a 15-year guarantee, and a 10-year guarantee for use on Accoya® and oak wood. Can be optionally used for the MULTI-MATIC, PROTECT, RAIL-SYSTEMS and ESPAGS product groups.



Current residential building trends are characterised by clean lines and the absence of superfluous elements. In terms of the window industry, this means that flush design, concealed hardware, narrow frames and aspects of home automation need to be taken into consideration. Burglary resistance is always taken into account as a basic requirement of every window. With its wide product range, MACO does not only meet these varied requirements, the company also keeps raising the bar when it comes to design, security and comfort.

TECHNOLOGY IN MOTION



QUALITY HARDWARE FOR WINDOWS

MULTI PRODUCT FAMILY

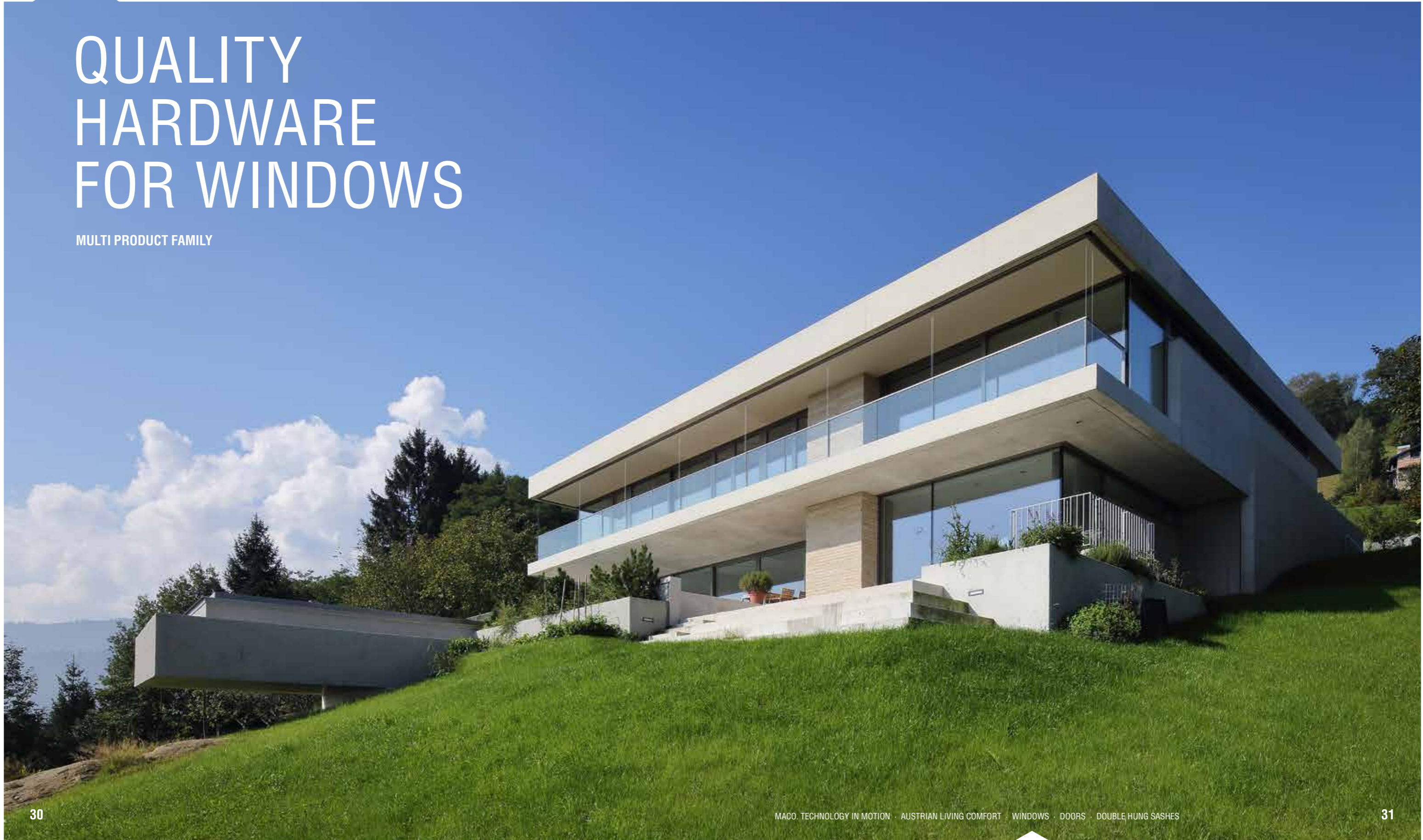

MULTI POWER

HIDDEN STRENGTH

Set yourself apart from your competitors and opt for the MULTI POWER hinge-side – the design range with concealed hardware components. Perfect aesthetics combined with maximum functionality and optimum security will fulfill all your customers' needs. Based on the MULTI-MATIC central locking system, with which it can be readily combined, you can easily create 1- and 2-sashed units and even 3-sash windows and tilt windows with concealed hardware. This means an extremely wide range of applications are at your disposal.

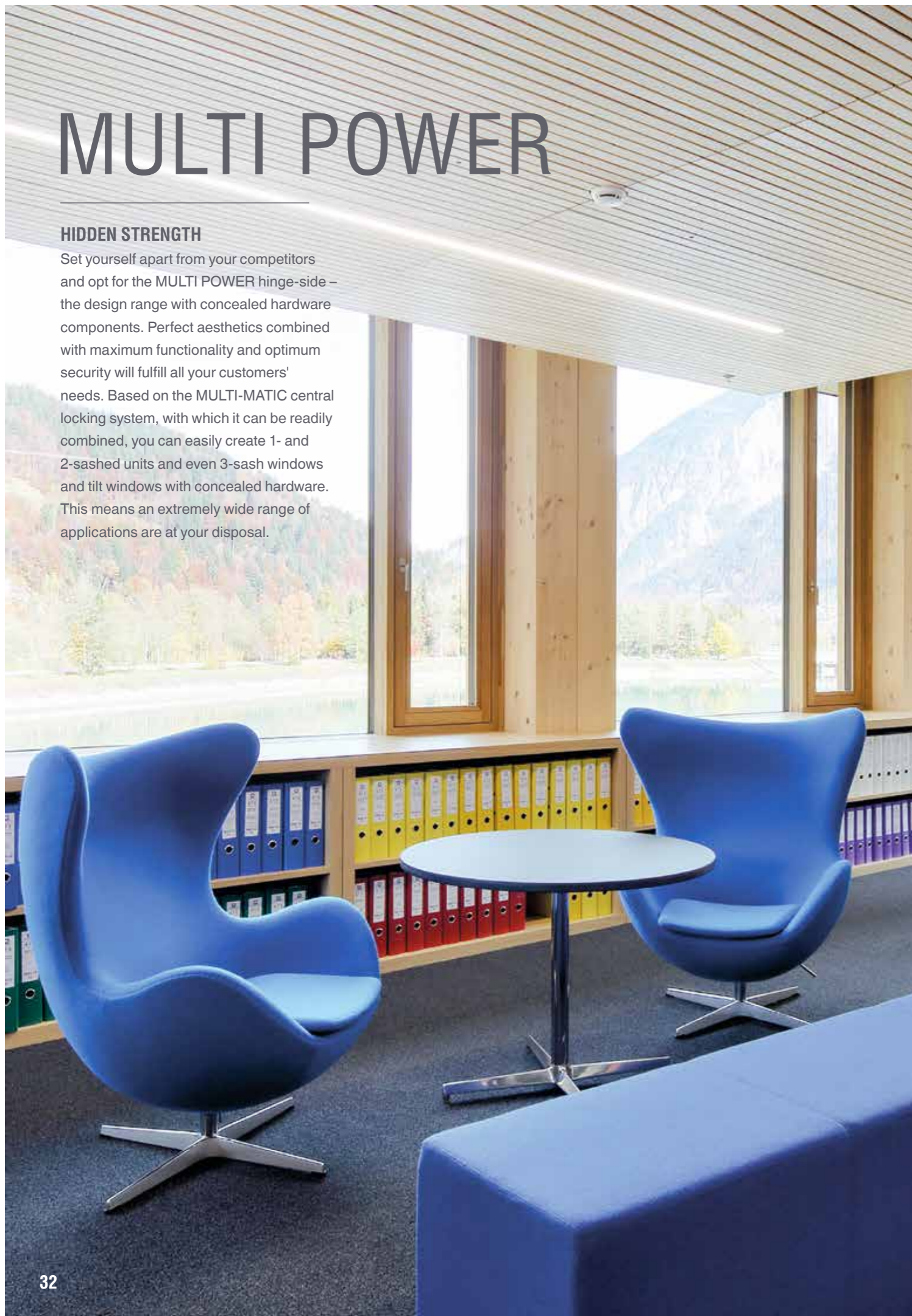

WIDE RANGE OF APPLICATIONS
YOU CAN EVEN PRODUCE 3-SASH WINDOWS AND TILT WINDOWS AS WELL AS 1- AND 2-SASHED UNITS, THANKS TO MULTI POWER AND ITS CONCEALED HARDWARE.

A MODERN LOOK

Windows and casement doors which have concealed hardware and bearing components when closed, become a design feature in modern residential buildings – MULTI POWER makes the production of such aesthetic window units child's play. With an additional flush design, the frame and sash combine to form a harmonious unit.

VIRTUALLY FRAMELESS

Timber windows with maximum glass areas where the frame discreetly retreats into the background – with MULTI POWER, narrow frames with a profile depth of 10 mm can be realised in a range of window dimensions with hardly any effect on the loadbearing capacity. The shadow joint becomes a design feature on the flush version.

BARRIER-FREE

Smooth transition between living space and balcony or garden – tripping is a thing of the past with timber casement doors thanks to the MACO-TRANSIT threshold. PVC casement doors with a sash weight of up to 130 kg can also be made barrier-free and convenient by combining them with thresholds from selected profile and threshold manufacturers (such as Veka, GKG, Trocal and Eifel TB).

RELIABLY SECURE

Even though MULTI POWER is a hit with design enthusiasts, this doesn't mean you have to compromise on optimum functionality and maximum security. The hinge-side has guaranteed burglary resistance up to grade RC 3. And the window units even fulfil RC 2 in combination with narrow frame profiles or thresholds.



MULTI MAMMUT

SECURE HOLD FOR HEAVYWEIGHTS

Modern architectural designs that consciously aim to integrate daylight usually feature large-scale glazing. In terms of movement and fastening technology, energy-saving, multi-glazed turn&tilt units are a weighty challenge, which MACO pivot posts and scissor stay hinges easily master. The hinge-side MULTI MAMMUT can handle huge windows with considerable sizes and sash weights up to 220 kg.



A STRONG HOLD
TIMBER TURN&TILT WINDOWS UP TO 220 KG, BURGLAR-RESISTANT UP TO RC 3 AND NO ROUTING ON THE FRAME.



ENERGY SAVING

As the new MAMMUT corner support for PVC windows and casement doors is only screwed at the rebate leg, thermal bridges and sealing gaps are now a thing of the past. At the same time, the casement door can be individually adjusted to suit the threshold so it is barrier-free. And there's another plus point: the easy fabrication – from manual assembly through semi-automated production to unmanned full automation.

TILTING UP TO 250 KG

Do you need the ultimate in design but don't want to compromise on fresh air? With MULTI MAMMUT you can now produce impressive tilt windows up to a sash weight of 250 kg and 5.6 m² in size. The modified hardware combination allows the timber window to be tilted, enabling shops or public facilities, for example, to be ventilated. A real alternative to fixed glazing and expensive air conditioning technology.

What's more, it also impresses with its easy fabrication, maximum security thanks to modified handle function and durability provided by wear-resistant materials.

POWERHOUSE

MULTI MAMMUT is the powerful solution for giant windows up to 3.6 m² and with sash weights of 180 kg in PVC, and now even up to 220 kg in timber! Burglar-resistant up to RC 3, without routing on the frames and with integrated anti-slam device as standard – set yourself apart from your competition and offer your customers the ultimate in flexibility.

DT160

A POWERHOUSE FOR GREATER COMFORT AND WARMTH

Modern construction and living combine large-scale window formats with extremely high energy efficiency requirements – the result is ever heavier window units. The new hinge-side can handle heavy timber casement doors up to a sash weight of 160 kg and thereby expands the existing dual-drill holes program – while maintaining full compatibility with the existing MULTI-MATIC parts.



ATTRACTIVE APPEARANCE GUARANTEED
THE NECESSARY ROUTING ON 4-GAP
SYSTEMS IS CONCEALED BY COVERS.

CONVENIENT INSTALLATION

Maximum convenience for you as a fabricator – as the DT160 can be combined with the existing DT130 range with ease. Fast maintenance thanks to integrated lubricant drill hole without unhinging the sash, a rubber gasket on the bottom of the dual-drill hole basic profile which allows for small variations in processing and easy, efficient assembly are also all plus points of the new hinge side.

TIMELESS DESIGN

Attractively shaped cover caps cover the pivot post and scissor stay hinges, thereby ensuring an attractive look. The new covers have the same design as the existing ones, which means they can be combined as desired. What's more, all new cover caps also match the DT130 range. This means maximum flexibility for you.

HIGH SECURITY GUARANTEED

Additional screw holes in the pivot post and scissor stay hinges ensure the necessary load distribution and a secure hold. What's more, the new hinge-side can be used up to burglary-resistance grade RC 3.

PIONEERS IN SECURITY



MECHANICAL SECURITY

Burglary-inhibiting technology is one of the key functional requirements of windows and doors. The longer a building element can thwart a burglary attempt, the safer an apartment or house is and the more secure its residents will feel. When it comes to security, mechanical burglary resistance is the key. Not only does MACO specialise in the development and production of burglar-resistant hardware, the company also offers complete security solutions for all unit sizes.

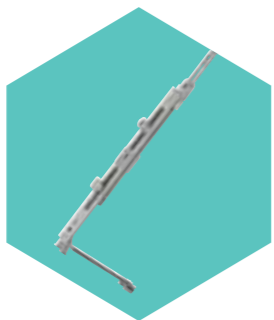

MACO BASIC SECURITY

When you purchase MULTI-MATIC i.S. hardware, you are buying a product where even the basic version offers a basic level of security. Security-relevant elements such as security striker plates on one or more burglar-resistant points guarantee increased protection, against vandalism and inexperienced opportunists, for example.

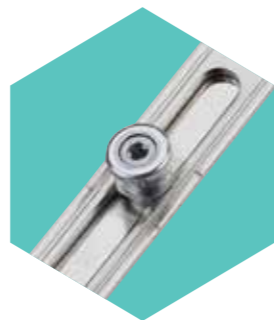

INTELLIGENT SECURITY

MACO i.S. security hardware for windows and casement doors have proven their burglary resistance in numerous tests at accredited institutes. They rank among the most innovative and completely reliable locking solutions on the market. The key feature of this system is the i.S. security roller cam. This slots, with its mushroom-like shape, in the stable i.S. striker plate, which is screwed into the frame. This makes it practically impossible to jemmy the door or window.



TESTED BURGLAR RESISTANCE

Windows fabricated according to EN 1627-30 offer optimal protection in six burglary-resistance grades to thwart burglars from opportunists to experienced thieves. With MACO i.S. you are opting for hardware products which guarantee tested functional and application security for a wide variety of profile materials and unit sizes up to RC 3 – and even up to RC 4 with selected materials.

MACO PROTECTS

MACO is the specialist you can trust when it comes to mechanical burglar resistance. A consistent focus on the latest security trends makes the Austrian hardware specialist one of the security pioneers in today's industry. With its RC solutions, MACO offers the most comprehensive security concept on the market.



SYSTEM TEST UNDER LICENCE

Benefit from our expertise and demonstrate your skills. You can obtain our test certificates for successfully tested MACO systems at any time in the form of licences. You can choose from over 20 different RC system tests with many profile manufacturers.



PIONEERING RC 3 WORK

Unique on the market: currently, windows with a burglary-resistance grade of RC 3 with a complete system matrix for units of all sizes are only possible with MACO hardware. Your crucial competitive advantage: as a licensee, you can use a wide system range and fabricate RC 3 elements without the need for in-house testing – at low cost.

In 2015, an extensive, first-of-its-kind RC 3 system test in timber was successfully passed. The new feature was a connection to the MACO-TRONIC contact for locking monitoring. Once again, MACO brought fresh ideas onto the hardware market.



ELECTRONIC SECURITY

Electronics are the perfect companion for mechanical burglary protection – they can ward off burglars in a similar manner to external movement detectors or alarm sirens – or forward a notification to an alarm system in the event of an attempted burglary. TRONIC is an electronic solution from MACO which is integrated into the hardware. It provides information about the locked position of a window and triggers an alarm as necessary. Optional tilt monitoring or heating control is also possible.

INTELLIGENT SECURITY FROM MACO

With MACO's intelligent security, you are always at the cutting edge. Unique window solutions protect residents and possessions, help to improve quality of life and can be used both in private and public spaces. They are real multi-talents.

IMPOSSIBLE TO SHIFT

Self-locking drive gear

The basic idea behind the self-locking drive gear is to automatically fix the deadbolt. It cannot be shifted, even if it is exposed during an attempted burglary, so it considerably increases the basic security of the window. This unparalleled solution can withstand a

force of more than 3 kN. It is easy to retrofit, quick to install and it is also low-cost, as there is no need for lockable window handles, the self-locking drive gear provides increased burglary protection.



SMALL BUT POWERFUL
EVEN IF A FORCE OF MORE THAN
3 kN IS APPLIED, THE DEADBOLT
CANNOT BE SHIFTED.



VENTILATION WITH RC 2
THE SASH IS OPEN 10 MM AT THE
TOP: AIR FLOWS IN BUT RAINWATER
RUNS OFF ON THE OUTSIDE.

VENTILATION (R)EVOLUTION

Secure ventilation

Do you want to provide ventilation by tilting the window but still enjoy the security offered by burglary-resistance grade RC 2? This can now be achieved with ease thanks to the further reduction of the ventilation position on turn&tilt windows. The sash sticks out 10 mm from the frame, ensuring permanent ventilation – even while the residents are away. For burglary-resistance grade RC 2, this must be combined with a rugged, lockable handle, such as the TRESOR handle.

This unique solution can be easily retrofitted with just one additional item and impresses due to its easy storage and logistics. Currently available and tested for selected PVC windows, MACO is now working on extending this to as many timber and PVC profiles as possible. Another advantage: the anti-slam device remains unaffected in both tilt positions if there are blasts of wind or similar.

Shown without rebate leg



UNIQUE SAFETY ADVANTAGE

Safety Pin

The unique Safety Pin prevents sashes up to 180 kg from falling out of the frame in critical scenarios, by holding it in place with robust steel cables. A sash can fall out for a variety of reasons: A child might pull and dangle from the window handle of an open or tilted window or a strong blast of wind can slam the sash against the window reveal. The anti-unhinge device "Safety Pin" should be part of the standard equipment in public buildings, in particular.

SKILFULLY THREADED
IN CRITICAL CASES, STEEL
CABLES PREVENT THE SASH
FROM FALLING OUT.



MODIFIED OPERATING SEQUENCE

Tilt-first version

Everyone knows the standard sequence for opening a window: turn before you tilt. However, windows or casement doors that are designed not to be fully opened with ease, in order to provide protection, for example, call for a different approach. This is where the tilt-first hardware with lockable window handle comes into play. It provides a different sequence of operation, making it suitable for public buildings such as schools, nursery schools, hospitals, residential care homes or hotels. Your advantages: You can use the standard hardware, replace just two hardware components and the handle and offer your customers a different opening solution. And all with low storage requirement and no additional assembly effort.

OUTSMARTED
THE MODIFIED SEQUENCE OF
OPERATION PREVENTS ACCIDENTS
IN PUBLIC BUILDINGS.



COMPLETE COMFORT FOR ALL



MAKING LIFE EASIER

Operate windows and casement doors easily. Take the threshold in your stride. Open and close the shutters without having to lean out. This should not be a luxury, it should be a normal part of day-to-day life. Normality embedded in the motto "barrier-free", which has long since become established in the world of modern architecture and living.

MACO offers you and your customers a variety of solutions designed to make everyday life easier – for the ultimate in operating convenience whatever your installation, situation or age.

UNRESTRICTED LIVING COMFORT

Deluxe hardware

Sometimes, we all find it difficult to reach a window: behind the sink in the kitchen, up high in the bathroom or staircase. The solution: MULTI deluxe hardware for PVC and timber windows. The window handle is positioned where it is easily accessible for every user – on the bottom casement. The window tilts and locks while the handle is being turned, without the user having to exert any pressure or force themselves. A handle with an elongated body provides increased leverage and makes operation child's play.

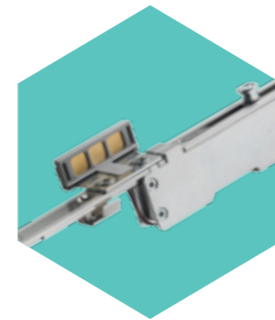

ULTIMATE OPERATING COMFORT

E-hardware

Tilt or close the window from the sofa via remote control – a breeze with the MULTI E-hardware: It combines manual and electromotive operation. This means that, if required, the window unit can also be operated with ease even in difficult-to-access areas. Alternatively, the window can be operated as usual by hand at any time. As a mechanical component which is suitable for Smart Home solutions, the hardware is integrated into the sash so that it is concealed, consumes little energy and is very easy to install.



NO MORE TRIPPING

Thresholds

Thanks to the MACO threshold solutions with their foot-friendly rounded edges and flat 20 mm design, tripping and associated injuries are now a thing of the past. Available for PVC and timber doors.



CAN BE OPERATED FROM INSIDE

Crank openers

To actuate the window shutter, the window must normally be opened first and then unbolted by leaning out of the window. But it doesn't have to be this way. MACO has the solution. When the window is closed, the window shutters can be easily opened and closed by means of a crank. A practical solution for fixed glazing or sliding windows, for example.

ESPAGS

CREATE SPACE

Windows that open out provide undreamt of open space in living areas and are used in Great Britain and Scandinavia, in particular. MACO ESPAGS espagnolettes also meet the highest security standards and offer maximum efficiency during installation.



R.A.I.L. ESPAGNOLETTES
THE REVERSE MUSHROOM
CAMS FULFIL THE HIGHEST
SECURITY STANDARDS.



INSTALLATION AND STORAGE EXPERT THANKS TO EXTENDABLE DESIGN

M-SPAG telescopic espagnolette

The special feature of the M-SPAG is its unique, patented telescopic function, which guarantees a previously unattainable level of efficiency during installation: the processing time is reduced, the risk of error is minimised. What's more, the modular system can be extended as required: it comes in five sizes so that window widths and heights of 320 to 1,500 mm can be fabricated. This reduces your storage requirements and storage is also made easier thanks to the innovative packaging. The flat design also makes the M-SPAG an attractive element. A high level of security – even during night-venting – is guaranteed by two steel shootbolt protrusions along with four security mushroom cams.

TESTED SECURITY AND DURABILITY

R.A.I.L. Espagnolettes

With its reverse action security mushroom cams which are positioned next to one another, R.A.I.L. meets the highest security standards. These have also been tested according to UK and European standards along with the long term performance and durability of the hardware. Striker plates with two positioning slots ensure secure night-ventilation. Combined with the high-quality MACO silver-look surface finish or as a premium version in extremely corrosion resistant TRICOAT-PLUS, the R.A.I.L. espagnolette is a real universal talent.

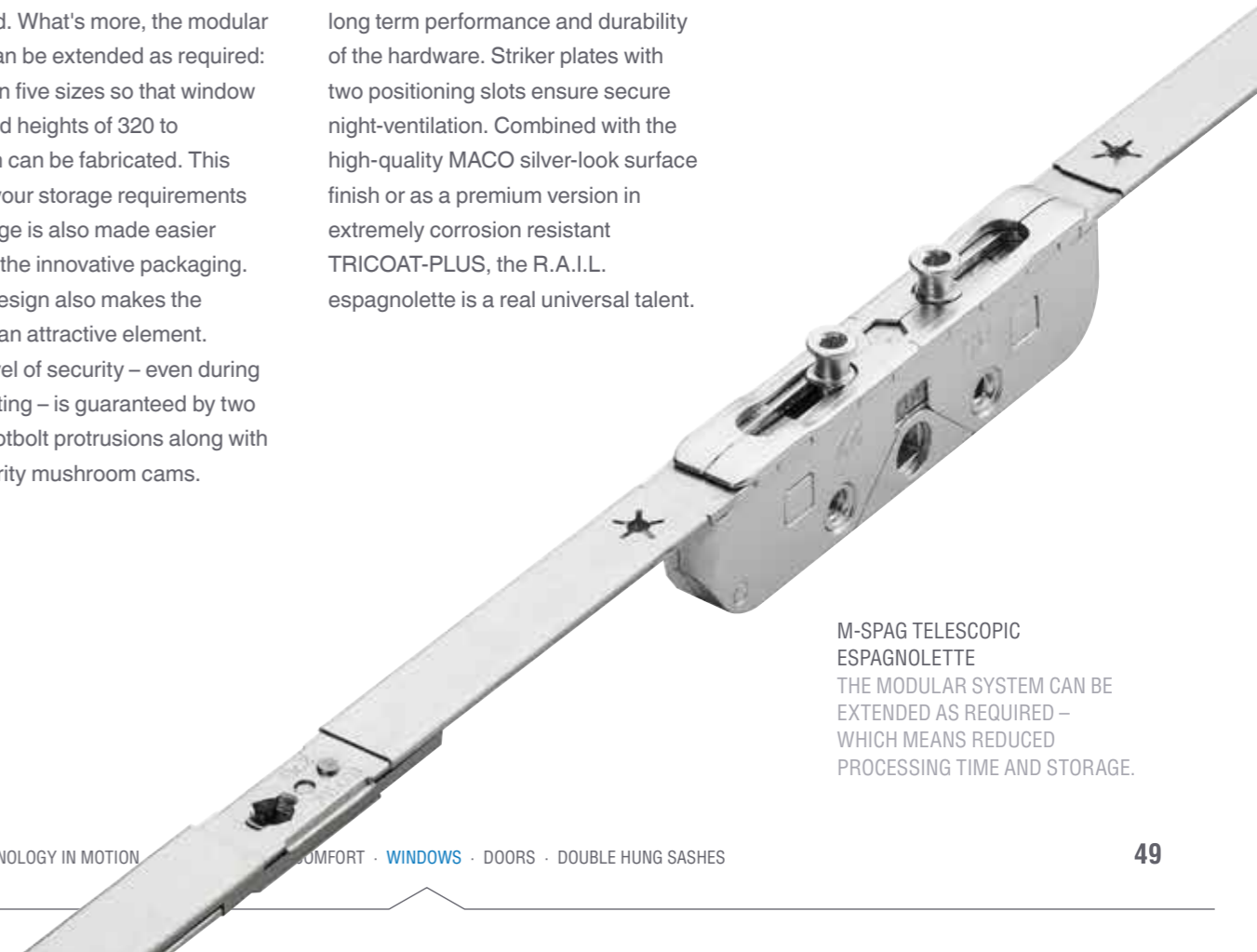

M-SPAG TELESCOPIC
ESPAGNOLETTE
THE MODULAR SYSTEM CAN BE
EXTENDED AS REQUIRED –
WHICH MEANS REDUCED
PROCESSING TIME AND STORAGE.

SETTING WINDOWS IN MOTION



THE CLASSIC: HARMONY
THE WINDOW HANDLE MATCHES STATE-OF-
THE-ART ARCHITECTURAL ENVIRONMENTS AS
WELL AS WINDOWS FOR OLD HALF-TIMBERED
HOUSES REPRODUCED TRUE-TO-STYLE.

EMOTION WINDOW HANDLES

Window handles are an important functional and stylistic feature. They are used to open and tilt a window and then close or lock it again. To do so, the handle must sit perfectly in your hand and operate the hardware smoothly. A window handle that can do this makes operating the window a pleasure, both functionally and in terms of look and feel.



PERFECT IN FORM AND FUNCTION

Our three design lines HARMONY, SYMPHONY and RHAPSODY meet all possible requirements for attractive shape and function. No matter whether you want to make an elegant understatement, create an ergonomic design, or a charismatic, timeless look, our handles add a unique, stylish touch to your windows.

LET'S TALK COLOUR

BRONZE, CHAMPAGNE, GREY-BROWN, SILVER, OR TITANIUM? YOU CAN CHOOSE FROM A WIDE RANGE OF COLOURS.



BLENDED TOGETHER

The countersunk TENTAZIONE handle is designed for particularly exquisite designer windows, as is integrated flush with the sash profile. The handle element and window sash blend to form a single unit.



SECURITY EXPERT

The extensive product range is rounded off by the rugged TRESOR window handle. As the specialist for burglar-resistance, it helps to create a home in which your customers can relax and feel secure.

Available in a wide choice of RAL classic colours, you can make use of the full range of possible colour schemes with our window handles.



REVITALISE YOUR QUALITY OF LIFE

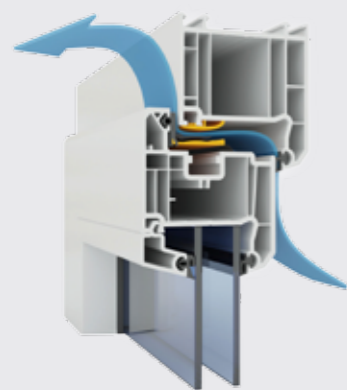

MACO-VENT VENTILATOR

Good indoor air quality is not only a decisive factor for the well-being and health of the residents, it also protects the structure of the building. Ever thicker building shells – particularly for energy-efficient refurbishments and new builds – call for a sophisticated ventilation concept to guarantee that air is exchanged and moisture is transported away. The most obvious ventilation option: the window.

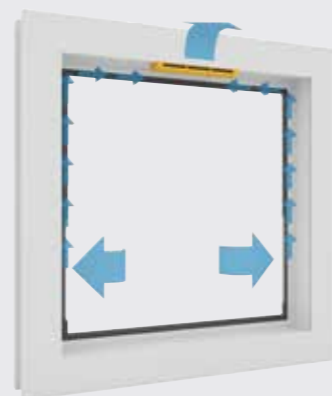

MOISTURE OUT – FRESH AIR IN

The concealed MACO-VENT ventilator which is directly integrated into the window rebate of PVC windows, naturally guarantees minimum ventilation, reliably and constantly – while the window is closed and without any action required by the tenant. And it does not affect the function of the window in any way. Another advantage: no risk of being denied insurance cover in case of burglary, as is the case with a tilted window.

FRESH AIR, MOISTURE PROTECTION & SECURITY
MINIMUM VENTILATION IS RELIABLY AND CONTINUOUSLY GUARANTEED
WHILE THE WINDOW IS CLOSED AND WITHOUT ANY ACTION
REQUIRED BY THE TENANT.



AERODYNAMIC ADVANTAGE

The 140 mm valve impresses with the best air permeability in its class at low wind conditions. Even in strong winds, its aerodynamic action prevents too much cold air from entering the building. Once a defined quantity of air is reached, the inflowing air volume is limited at the same time, the outside air coming in via window rebate is permanently pre-heated. Cold draughts are thus a thing of the past.

YOUR KNOWLEDGE – YOUR ADVANTAGE

A ventilation concept is essential for new builds or modernised buildings that need ventilation-relevant modifications. With the MACO software tool, the relevant requirements can be determined and used to derive needs-based ventilation measures. The MACO ventilation competence centre also offers further useful services which provide specific ventilation know-how – relevant for window manufacture. Become an expert on moisture damage, liability risks and standards!

YOUR ADDED VALUE – YOUR ADDED BENEFITS

- User-independent, natural ventilation for reliable exchange of air and protection against moisture according to DIN 1946-6
- Low maintenance
- Can be retrofitted with little effort (regardless of the window hardware brand)
- Cost-effective purchase, no wear and tear
- Easy to clean and maintain without third-party companies
- No uncontrolled loss of heat

With PROTECT, MACO is offering you a wide range of door lock solutions, which meet all customer needs. Features such as i.S. security roller cams, steel hooks and bolts or hook-bolt combinations prevent forced entry from outside. Optimum sound and heat insulation and innovations, such as modern access control systems for extremely easy, fully automatic operation via mobile app, for example, also help to ensure maximum convenience at home.

TECHNOLOGY IN MOTION



INNOVATIVE SOLUTIONS FOR DOORS

PROTECT PRODUCT FAMILY



WANT EASY ACCESS MANAGEMENT? THEN YOU NEED MACO OPENLIFE!

INTELLIGENT ACCESS CONTROL in real time

Open the door for the postman to make a delivery, even when nobody is at home. Let your son, who has forgotten his key again, into the house, even though you are still at work. Tilt the window remotely while you're out and about, so you can come home to a ventilated house. MACO openLife – the modern, location-independent, real time access management system – brings more flexibility, convenience and security to your customers lives.

We combine our motorised hardware (such as Z-TA 3-latch automatic locks or the MACO E-hardware for windows) with electronic components from global market leaders (wall readers, E-cylinders, etc.) to create a completely new, unique access system. For you, it is wireless and can be installed with little effort. For your customers, it is easy and intuitive to use.



WIRELESS HARDWARE
THE DISCREET ELECTRONIC WALL
READER TAKES JUST A FEW MINUTES
TO INSTALL. COMMUNICATION
TAKES PLACE VIA M2M MOBILE
COMMUNICATION.

ACCESS ORGANISATION MADE EASY

via web interface

By using a secure login on the online platform www.macoopenlife.com or by using the associated openLife app, users can create additional users, grant and revoke access rights in real time and open doors and windows remotely or while they are on the go, from any location. They can also see an overview, which shows who has operated which doors and windows and when. Doors and windows can also be opened locally with a transponder tag and reader unit.

HIGHLY SECURE thanks to encryption

No more security risks associated with losing a mechanical key, no more annoying and expensive cylinder and key changes: with MACO openLife, all communication between the components is encrypted and therefore protected against interception and replication. Critical security processes have a double layer of security: after entering a personal code, a verified smartphone must also be used.

PRACTICAL FOR ON THE GO USE
OPENLIFE CAN BE CONVENIENTLY OPERATED
VIA MOBILE APP OR LOCALLY BY MEANS OF
TAGS, RFID-BASED KEY RINGS.



G-TA

HANDLE-OPERATED AUTOMATIC LOCK

The G-TA provides all the options that fabricators and end users desire: a door lock range that is versatile for use with main doors, back doors and balcony doors. With a choice of automatic or mechanical control. And it can now also be combined with handle-based access systems.



INTELLIGENT LOCK
IF THE SASH IS CLOSED, A SPRING ASSEMBLY IS TRIGGERED VIA THE ROCKER: THE LOCKING PINS "SHOOT" DOWNWARDS.

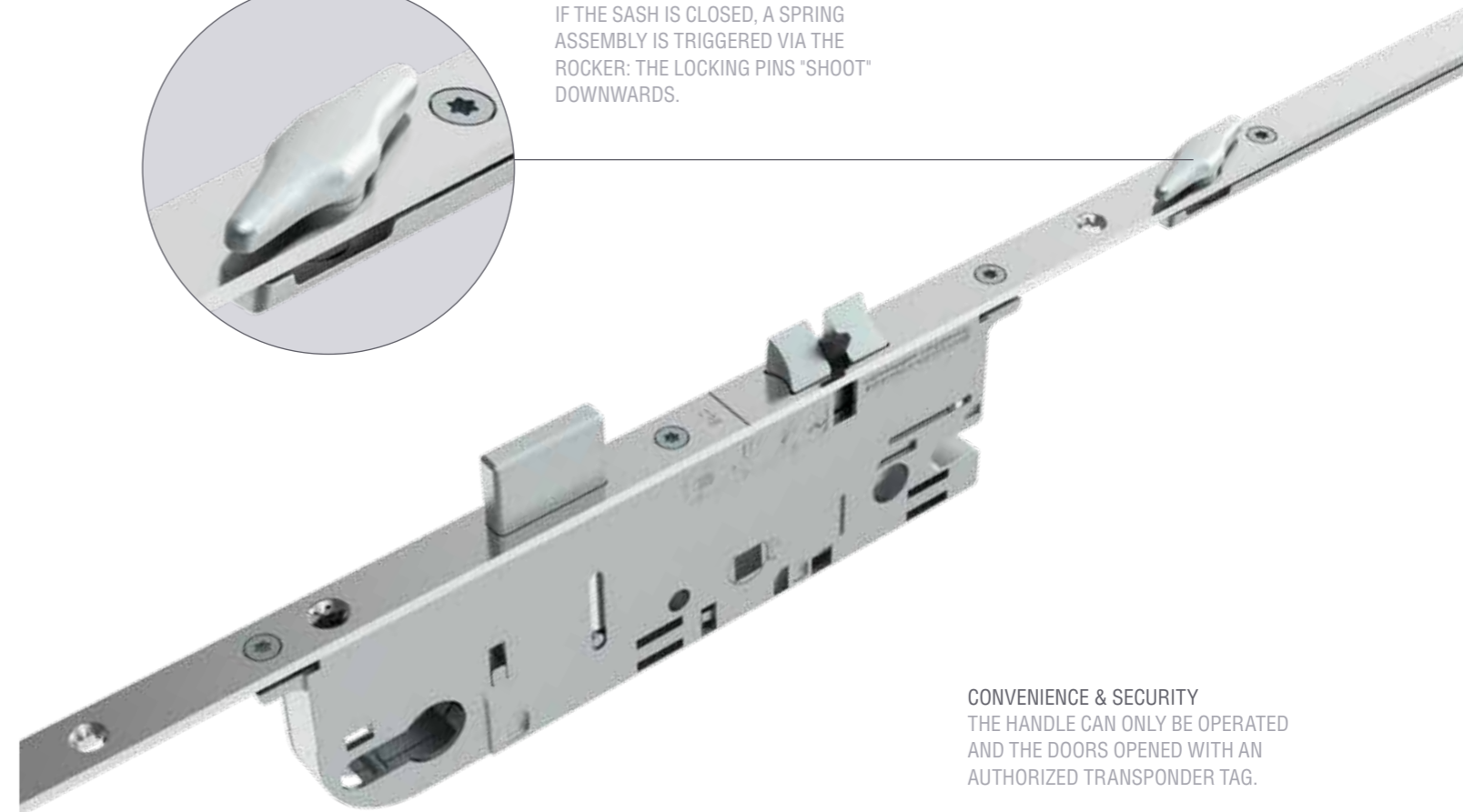

CONVENIENCE & SECURITY
THE HANDLE CAN ONLY BE OPERATED AND THE DOORS OPENED WITH AN AUTHORIZED TRANSPONDER TAG.



THE HANDLE AS AN ALL-ROUND TALENT

The G-TA provides maximum convenience – because it locks automatically. It requires only minimal processing, can also be easily used on 2-sashed doors at a low cost and offers a high security standard for the door lock solution: the five-point locking guarantees tested burglary-resistance grade RC 2.

ACCESS SYSTEMS WITH OPTIMAL INTEGRATION

The G-TA is also suitable for combining with handle-based access systems: the door handle is decoupled on the outside of the door. The handle only couples, so that the door can be opened, once an authorised transponder tag is detected. Access can also be controlled via mobile phone (app).



Z-TA

3-LATCH AUTOMATIC LOCK

This door offers one thing above all: security. When the door is closed, the hooks and locking bolt automatically engage – a key is not needed. The trick? Magnetism.

You can offer your customers even more convenience with motor and access system combination.

A credit card, fingerprint or car key then replaces the door key. The door is opened by means of a motor, without any action by the user.

MAGNETISM
THE AUTOMATIC LOCKING IS TRIGGERED BY A MAGNET, WHICH IS POSITIONED ON THE FRAME-SIDE IN THE STRIKER PLATE.

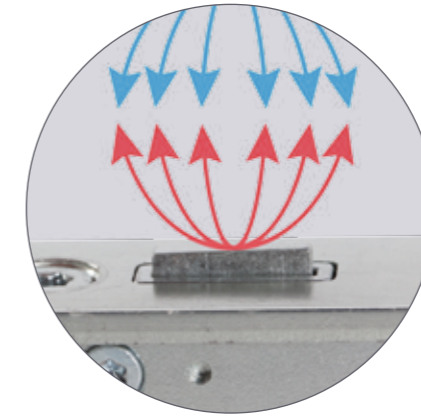

SEALED AND SECURE

The gasket compression across the entire height of the door, which guarantees optimum impermeability, heat and sound insulation, is not the only impressive aspect of the Z-TA. The lock, which is automatically triggered by a magnet when the door leaf is closed, also provides a pleasant sense of security. The steel hooks and locking bolt then engage completely mechanically, and fully lock the door. Residents do not need to lock the door with a key.

The door is easily opened via the cylinder, from the inside using the handle, or optionally via the motor. Equipped with a motor and combined with openDoor or other commercially available access systems, the door can also be opened automatically via fingerprint or car key for example.

UP TO DATE
THE Z-TA CAN BE OPTIONALLY COMBINED WITH MODERN ACCESS SYSTEMS SUCH AS OPENLIFE. THIS MEANS THE DOOR CAN ALSO BE CONTROLLED VIA MOBILE PHONE APP.

C-TS

HANDLE-OPERATED COMBI LOCK

For MACO, security is more than burglary resistance. When it comes to extreme weather phenomena, the hardware professional is a strong partner with specific building elements.

For example: the new flood protection setup for the C-TS. This prevents the increasingly frequent floods from devastating the homes of your customers.



ABSOLUTELY SECURE, FLOOD PROTECTION INCLUDED

With the special C-TS flood protection setup, your customers' homes are also protected against floods. Doors fitted with this setup can easily withstand a water column of almost one metre for 48 hours. We have already tested this for you in accordance with conventional security standards. And despite the 15 locking points required for the flood setup, the C-TS impresses with its high level of operating convenience.

ONE LOCK CASE, TWO FUNCTIONS, HIGH SECURITY

Thanks to the split spindle, the C-TS combines the handle and alternate operation in a single lock case. But that's not all. The lock is also a real security pro: the hooks made of forged steel and the solid steel striker plates make life particularly difficult for burglars. The tested burglary protection (burglary-resistance grade RC 2 as well as PAS24) is also optimised by the installation of additional locking points in the form of the proven i.S. security striker plates.

TESTED SECURITY
WITH THE FLOOD SETUP, A TOTAL OF 15 LOCKING
POINTS PROTECT THE HOMES OF YOUR CUSTOMERS –
FROM VOLUMES OF WATER AND BURGLARS.



Z-TM

3-LATCH MOTORISED LOCK

Never have to search for your keys again? Never want to have to stand in front of a locked door with heavy shopping bags? With the new fully motorised door lock, not only can the front door be opened with ease by means of fingerprint or car key. Thanks to the swing door drive, the door also opens completely automatically, all by itself.



MACO OPENDOOR
THE ACCESS CONTROL SYSTEM CAN BE CONTROLLED VIA TRANSPONDER (E.G. CAR KEY, CREDIT CARD) OR OPERATED BY FINGERPRINT SCANNER.

- 1 | FINGERPRINT
- 2 | CAR KEY
- 3 | TRANSPONDER
- 4 | CREDIT CARD

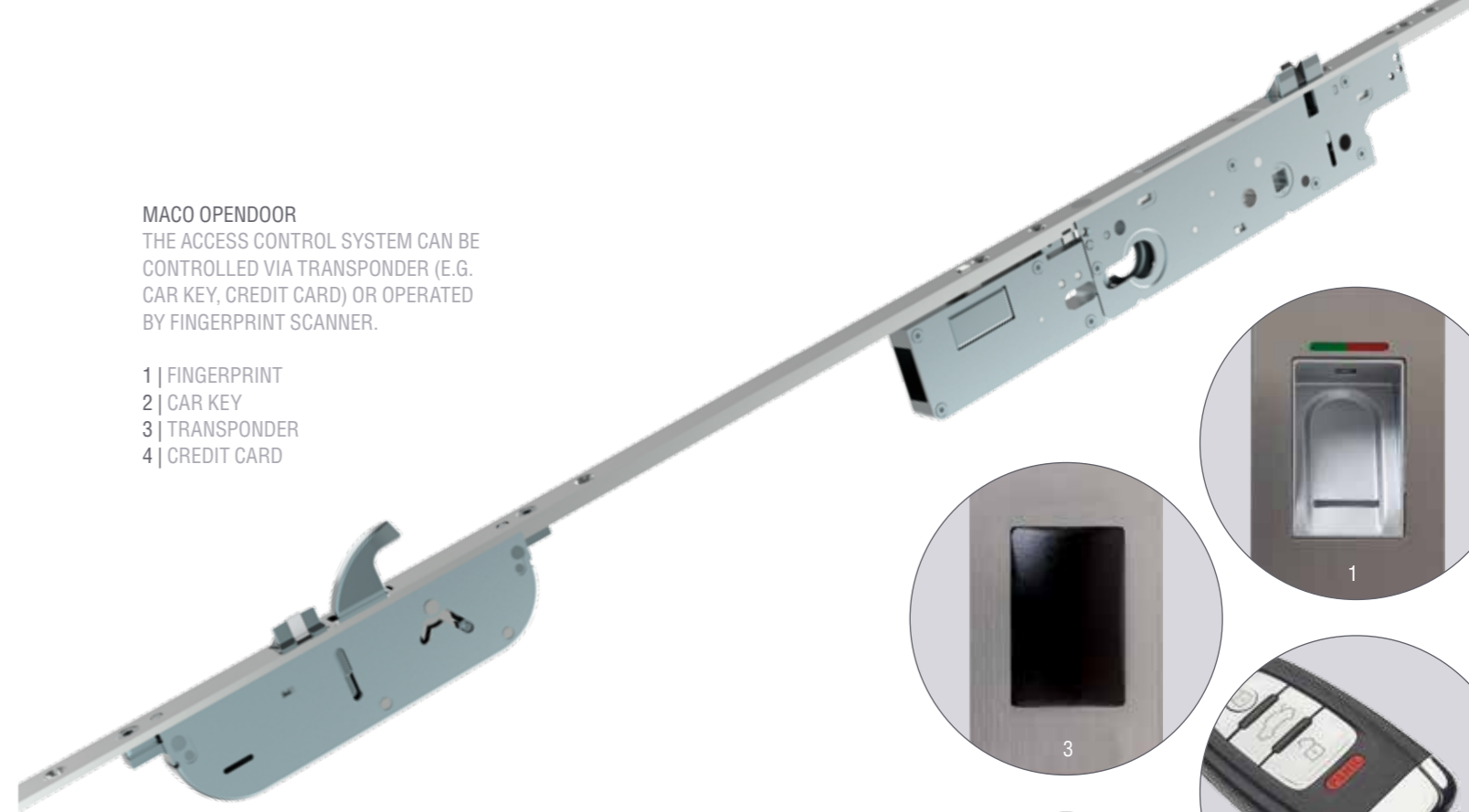

THE BEST COMBINED
MAXIMUM IMPERMEABILITY AND OPTIMUM
HEAT AND SOUND INSULATION ARE PERFECTED
WITH A SECURE MOTORISED LOCK.



ULTIMATE IN CONVENIENCE FOR YOU AND YOUR CUSTOMERS

Based on the tried-and-tested Z-TF 3-latch lock, MACO is now launching a fully motorised door lock solution onto the market for the first time. It complements the advantages of the adjustable and automatic gasket compression, the improved impermeability and the optimised heat and sound insulation of our proven 3-latch technology with a 100% secure motorised lock. Key advantages: low-energy operation & fast, quiet motor locking and unlocking. What's more, the fabrication is incredibly easy.

MODERNITY HAS ARRIVED

Combined with the openDoor access control system, the doors now unbolt automatically, by unlocking them with a car key, fingerprint or credit card, for example – and thanks to the swing door drive, the doors also open by themselves.

An extremely convenient solution which fulfils a market need, for situations such as when your hands are full with shopping bags.

MACO OPENDOOR

The tried-and-tested access openDoor control system makes an impact thanks to its outstanding aesthetic appearance – the reader unit with high-quality stainless steel covers is embedded directly in the door leaf. The control unit is installed inside: this protects it from manipulation by unauthorised parties. A perfect blend of security, design and convenience.

PRO- DOOR T100R

PARTIALLY CONCEALED BUTT HINGE

The aesthete of the front door hinges impresses with its discreet appearance: When installed, you can only see the hinge-roll.

For you, as a fabricator, extremely easy installation is paramount: the frame and sash can be installed together. The only one of its kind on the market.



DISCREET DESIGN
THE PARTIALLY-CONCEALED DOOR HINGE CAN BE ENHANCED IN A WIDE VARIETY OF HIGH-GRADE ANODISED SURFACE FINISHES.



DESIGN & DURABILITY IN PERFECT HARMONY

The high-quality look of the MACO PRO-DOOR T100R is captivating: When installed, only the hinge-roll is visible on this partially concealed door hinge for PVC front doors. The aluminium body of the T100R is available in a wide range of RAL colours with numerous anodized surface finishes, making every hinge on the door eye-catching.

AN EFFECTIVE POWERHOUSE

The butt hinge, made from high-strength aluminium extrusion press profiles, can support sash weights up to 100 kg. Like all MACO door hinges, the T100R can also be adjusted in three dimensions and even adjusted while hung. The unique patented ball bearing of the axle pin prevents the door sash from dropping and guarantees long-term function without maintenance.

The hardware for ceiling-height, large-format units in all materials offers deluxe operation and large opening widths. Even multi-sashed designs are easy to slide. They open up the space and provide almost "flush to floor level" access. Unique locking mechanisms on the sash and frame guarantee maximum burglar resistance. The extremely corrosion-resistant TRICOAT-PLUS surface finish rounds off the range.

TECHNOLOGY IN MOTION



HIGH-QUALITY SYSTEMS FOR SLIDING UNITS

RAIL SYSTEMS PRODUCT FAMILY

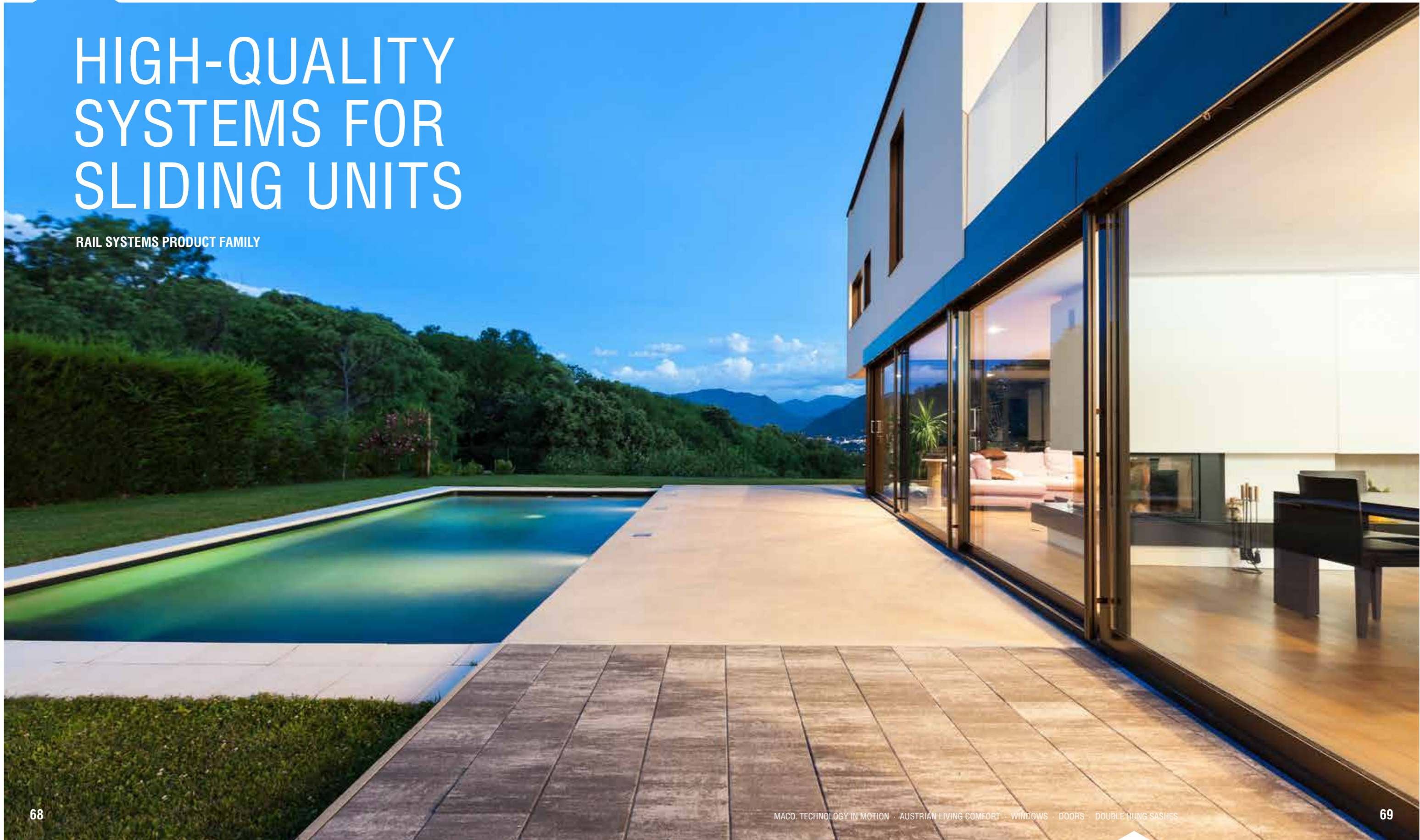

PANORAMA SYSTEM

FOCUS ON DESIGN

Benefit from a full range of the highest quality from a single source. The Panorama design line offers a range of design options for timber and timber/aluminium systems: frameless fixed glazing, very narrow frame designs of just 80 mm in width, sash weights up to 400 kg and the large range of versions cover all possible design requirements. Rooms flooded with light, as often called for by modern architecture, are thus a reality.

Maximum flexibility in terms of the design also enables the fixed glazing to be installed from inside or outside, providing an unobstructed panorama adapted to suit the building situation in question.



CONCEALED LOCK
THE LOCKING HOOK COMPLETELY RETRACTS INTO THE SASH WHEN THE DOOR IS OPENED. THE ADVANTAGE? THE HOOK DOES NOT DETRACT FROM THE LOOK, NO RISK OF INJURY.

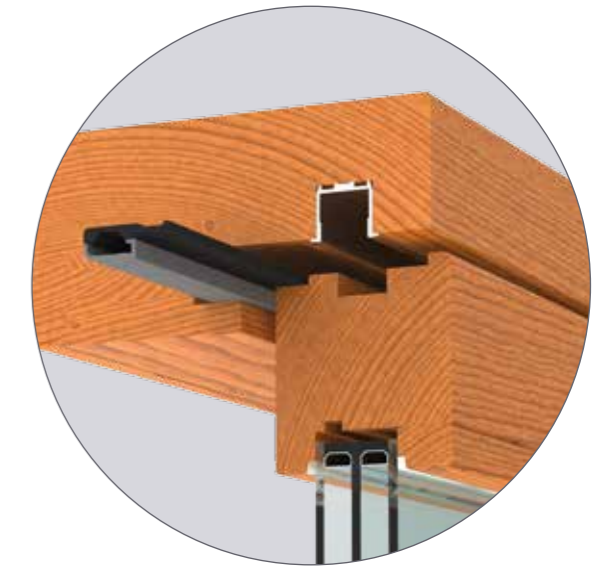

MAXIMUM IMPERMEABILITY, DISCREETLY CONCEALED DESPITE THEIR SPACE-SAVING DESIGN, THE GASKET TRACKS ARE CHARACTERISED BY THEIR EXCELLENT THERMAL PROPERTIES.

UNOBSTRUCTED VIEW

Concealed steel hook drive gear for all schemata

Nothing interrupts your view, there are no protruding locking parts, everything is smooth and even. This is because the steel locking hooks only emerge and pull the lift&slide sash to the frame when the door is closed – at all other times they are concealed. This also prevents any risk of injury. The finishing touch comes in the form of striker plates to match the colour of the frames.

EXPANDED HORIZON

Narrow horizontal gasket track

The unique narrow thermo gasket strip is mounted horizontally at the top of the sliding sash. Thanks to its extremely space-saving design, it is barely noticeable and enables more light to enter the passage area. It also impresses with its thermal properties, high wind and watertightness plus it reliably prevents condensation formation.

INDIVIDUALLY TAILORED

Panorama in timber

Thanks to novel accessories, all the advantages of Panorama (such as frameless fixed glazing, narrow frame friezes and barrier-free design) are now also available for pure timber systems.

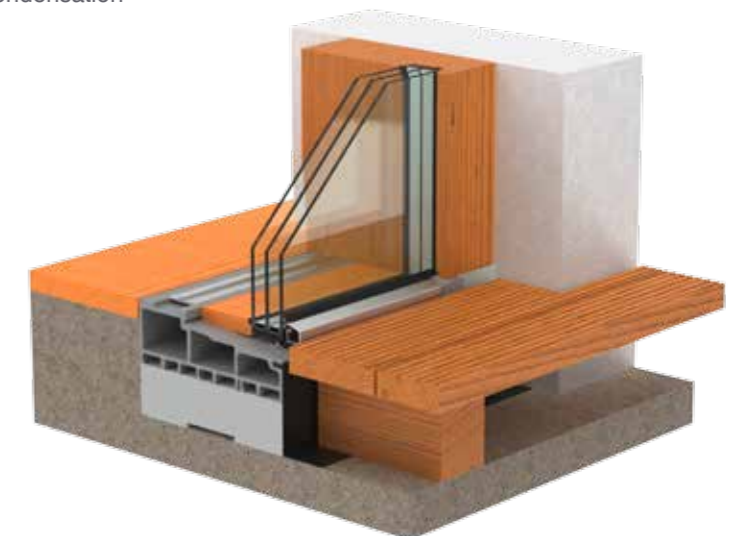



TRIP-FREE
THE FLAT ROLLER TRACK IMPRESSES WITH ITS LOW HEIGHT OF JUST 5 MM.

BARRIER-FREE DESIGN INCLUDED

GFRP threshold

Combined with the GFRP threshold with flat roller track (low height of 5 mm) and the low threshold tread board, the lift&slide solution is barrier-free according to ÖN and DIN: the risk of tripping is eliminated, the boundary between inside and outside disappears.

A FEEL GOOD EXPERIENCE

Silicone sash gasket

Not only does the new silicone sash gasket provide improved, permanent impermeability thanks to its durable, temperature-resistant material, it also optimises operation by noticeably reducing the closing pressure and minimising any noise during opening and closing. Its shape, which is

adapted to suit the corner, is unique on the market: for the first time in the window industry, a special process has made it possible to also connect silicone seals permanently in the corners. This means that MACO is the first company to supply silicone gaskets on lift&slide units.



TURN A CORNER
BY USING A SPECIAL PROCESS, THE NEW SILICONE SASH GASKET FOR LIFT&SLIDE UNITS CAN ALSO BE PERMANENTLY CONNECTED IN THE CORNER.



FIRMLY LOCKED

Steel hook drive gear

The concealed steel hook drive gear provides sophisticated functionality: when the door closes, the hooks silently engage into the frame-side, flush recessed striker plates without contact. Here, the dead weight of the sash is used to firmly anchor the hooks in the frame. As well as the high level of mechanical burglary resistance up to RC 2, the flawless design of the solution is also impressive.

CLEVER LOCK
THE DEAD WEIGHT OF THE SASH IS USED TO FIRMLY ANCHOR THE HOOKS IN THE FRAME.

MONITORED AROUND THE CLOCK

Locking monitoring

The new locking monitoring provides a sense of maximum security. It reliably indicates whether the lift&slide unit is open or locked. This data is transferred to smart home solutions or heating control systems, for example. If it is transmitted to alarm systems, then the units can be electronically secured, even when the residents are away – so your customers can put burglars to flight.

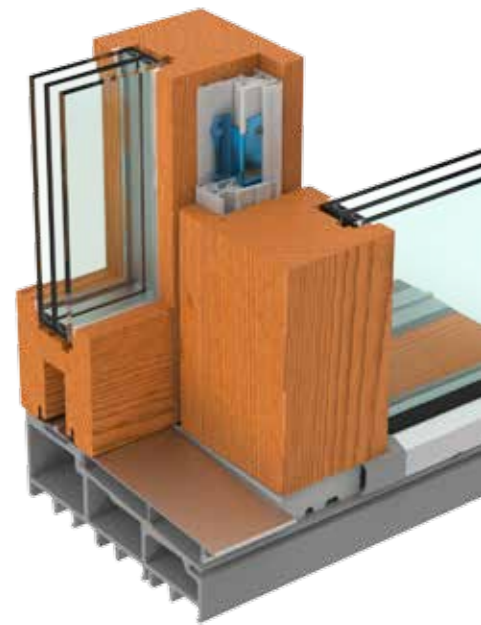

SECURE, SEALED AND BARRIER-FREE

Hinge security provision

The hinge security provision on PVC gasket tracks also provides security according to RC 2. However, this does not affect the excellent gasket track properties in regard to the required space, wind and watertightness or thermal aspects in any manner. Nor does it prevent a barrier-free design. It can be retrofitted and installed so it is concealed, which means that it can be used to create giant windows which offer your customers convenience, design and, above all, security.

ELECTRONICALLY SECURED
A MAGNETIC SWITCH INDICATES WHEN THE LIFT&SLIDE UNIT IS OPENED AND OPTIONALLY TRANSMITS THIS TO AN ALARM SYSTEM.



PVC SYSTEMS

UNIQUE INDIVIDUALITY

With its main product group RAIL SYSTEMS, MACO has been setting the pace for convenient high-performance, attractively designed sliding solutions for timber units for years now. Now the full-range supplier has also developed individual hardware solutions for PVC together with the major profile manufacturers on the market. This means that MACO is the hardware supplier for all standard PVC lift&slide systems and is integrated into the cascading process of the relevant system suppliers.



INTEGRATED BRUSH TECHNOLOGY
SPECIAL BRUSHES, WHICH REMOVE
THE DIRT BEFORE EACH SLIDING
OPERATION, HAVE BEEN INTEGRATED
INTO THE ROLLERS TO KEEP THEM
PERMANENTLY CLEAN.

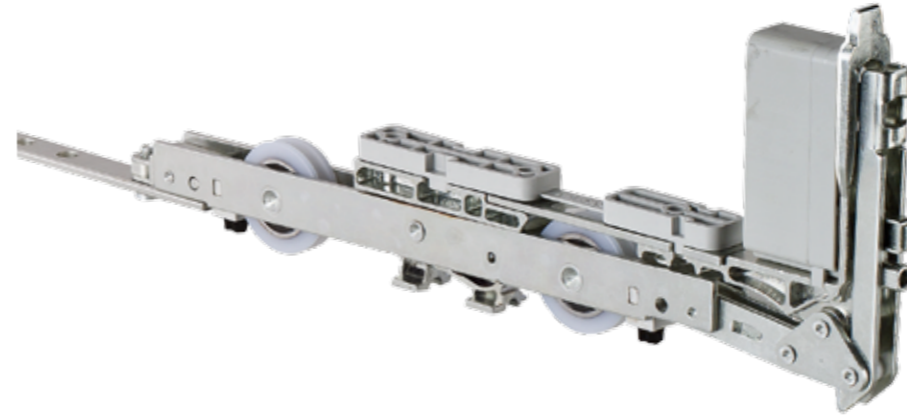

SMOOTH MOVEMENT Rollers

Unique to the market, every PVC system using the lift&slide roller comes as standard with special brush technology. These brushes, positioned in front of the rollers, remove dirt such as builder's dust, sand or pet hair from the roller track each time it is operated. This preserves the rollers even during the building stage, so that the unit can continue to slide smoothly!

ALL CONCEALED Locking

The concealed lock, which is adapted to suit the relevant profile, including in terms of colour, guarantees an attractively shaped design. Annoying cams and corners on frames are passé, nothing interrupts the view. When the door closes, the hooks silently engage into the frame-side, flush recessed striker plates without contact.

NO PROTRUSIONS
THE STRIKER PLATES ARE EMBEDDED
FLUSH INTO THE FRAME, THE HOOK
CONCEALED IN THE SASH ONLY
EMERGES WHEN THE DOOR IS CLOSED.



BARRIER-FREE THERMAL PRO THRESHOLDS WITH LOW HEAT TRANSITION COEFFICIENTS (U-VALUES) ARE ENHANCED WITH OPTIONAL INSERT PROFILES.

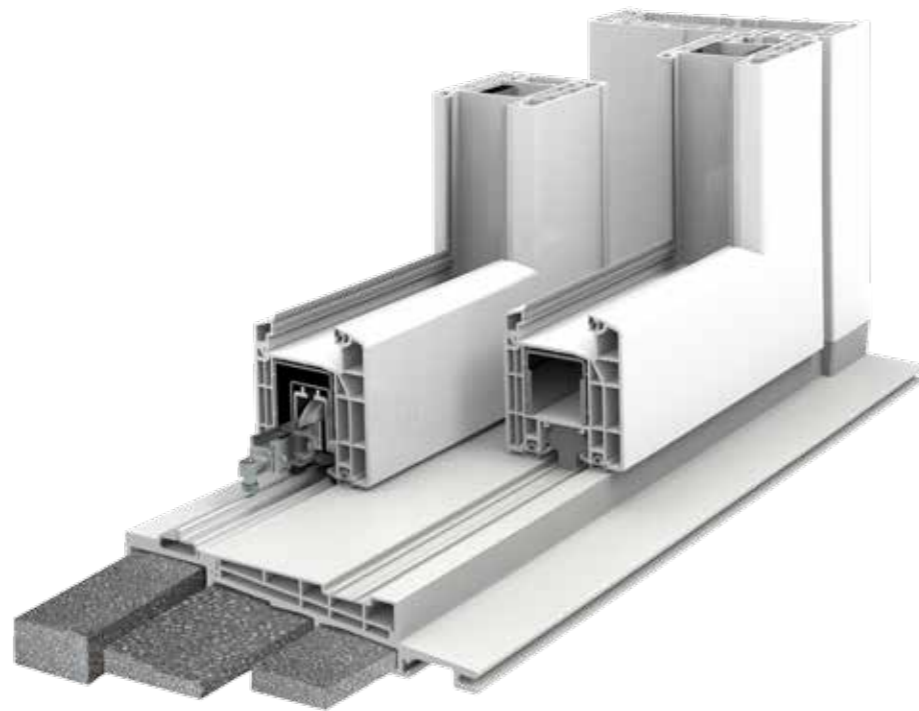

ABSOLUTELY SECURE & EASY TO INSTALL

Connecting rod

Flat steel with pre-drilled holes joins the rollers together. Special supporting pins and screws ensure a secure join and prevent the connecting rod from sliding out, throughout the life of the product. The connecting rod is put together outside the PVC chamber and guarantees simple, swift installation in one piece.

SPECIAL INSTALLATION TRICK PREVENTS ERRORS

PVC spacer bars

Clip-on PVC spacer bars are available in different sizes based on the various manufacturers' different profile groove versions. This ensures that the MACO hardware will fit the available profile perfectly. A positioning nib ensures correct positioning and helps to avoid errors during installation.

OPTIMAL THRESHOLD INSULATION

Threshold

Barrier-free passage on PVC lift&slide systems too? Thanks to the MACO threshold, this is no longer just a dream. A thermal barrier is not required from the outset due to the low coefficient of heat transfer of the threshold made from glass fibre reinforced PVC. If the optional insert profiles are used, the threshold achieves an incredible U-value.

OPTIMUM PROFILE-RELATED BURGLARY RESISTANCE

Security assets

The standard hardware design already provides the basic security level RC 2. It can be retrofitted without ease. The RC 2 test has already been successfully passed by many of the 24 PVC lift&slide profiles which can currently be equipped with MACO hardware. In addition, the optional locking monitoring ensures that PVC large-format units, which you can produce with just a few accessories, are highly-secure.

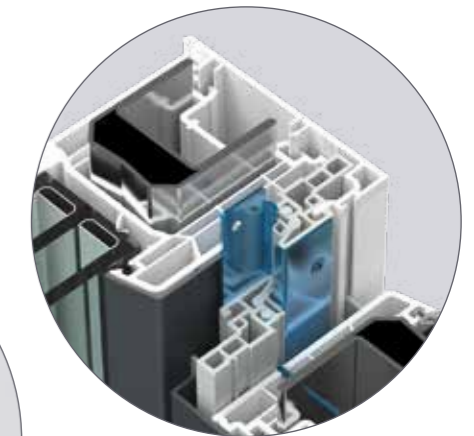

COMPLETELY SECURE SOLUTIONS SUCH AS LOCKING MONITORING OR THE HINGE SECURITY PROVISION ENSURE THAT THE PVC LIFT&SLIDE UNITS ARE RC 2 COMPATIBLE.

RC 2 AS STANDARD

Anti-drill plate

The anti-drill plate can be installed quickly and easily and can be retrofitted. It prevents the lock case from being drilled open from the outside, thereby preventing the lift&slide unit from being opened. The tested anti-drill plate is used for large-format units with burglary-resistance grade RC 2.

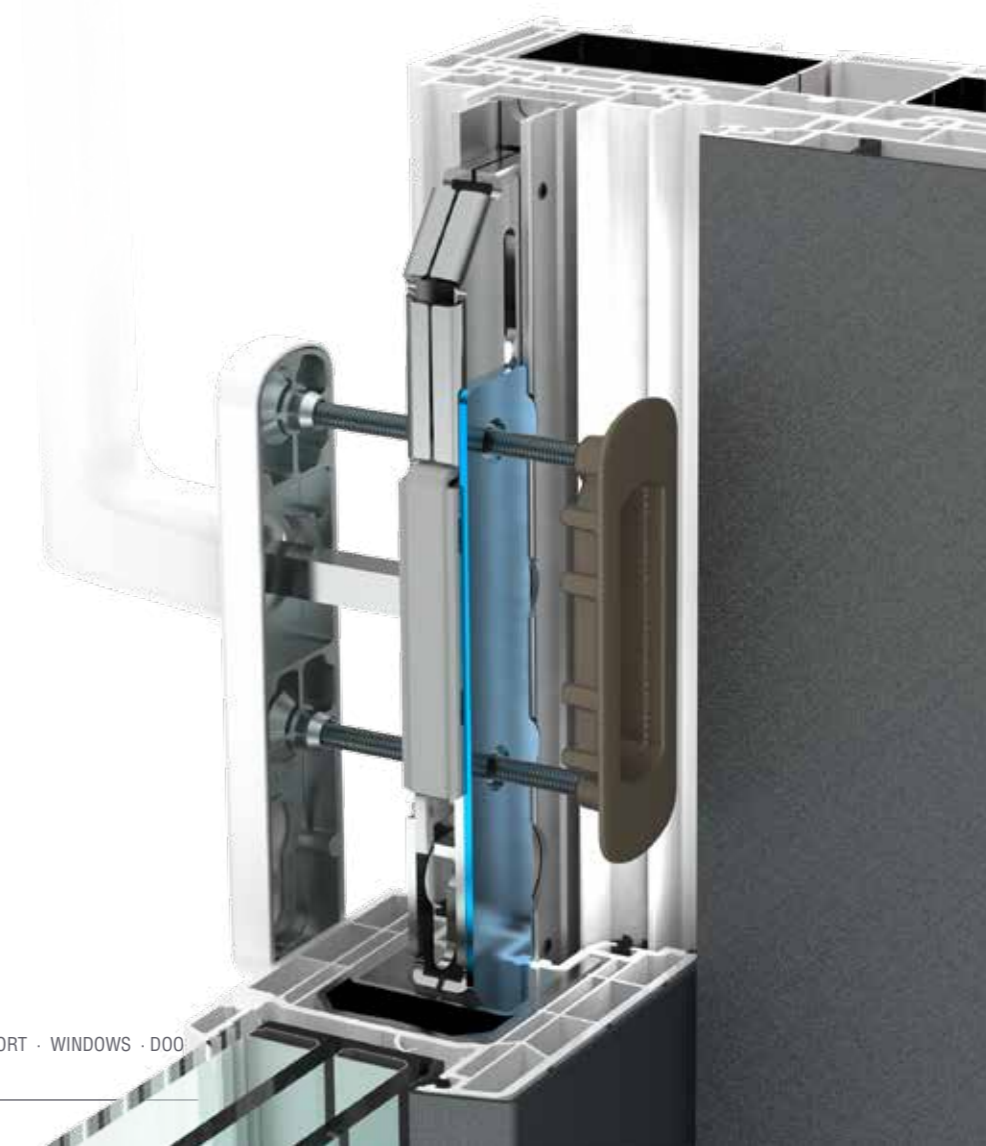

PARALLEL-STOP SLIDE HARDWARE

SECURE VENTILATION FOR LARGE-FORMAT UNITS

The high-quality PAS hardware sliding solution with parallel stop complements the RAIL SYSTEMS main product group. It is based on the proven roller technology of the MACO slide&tilt hardware. The variety of striker plates offered for the various profile types mean that PAS can be used for timber, timber/aluminium, and PVC windows and casement doors. In addition to effortless operation of the sash units that can weigh up to 200 kg, the even peripheral ventilation with parallel stop, plus the optionally available, extremely corrosion-resistant TRICOAT-PLUS finish are the top features of the system.



SLIP RESISTANCE
A REBATE COVER CONCEALS UNATTRACTIVE SCREWS AND COMPENSATES FOR THE LEVEL DIFFERENCE BETWEEN THE STRIKER PLATES FINISHED WITH TRICOAT-PLUS AND THE EUROGROOVE.

FOCUS ON DESIGN

Smooth transition

It is not just the narrow frames that provide an attractive appearance: the TRANSIT-PERSONAL threshold also allows for a discreet, clear design: a slip-resistant rebate cover conceals installation and fixing screws and compensates for the level difference between striker plates and Eurogroove. So no protruding hardware components can detract from the appearance.





EFFORTLESS OPERATION
 THANKS TO THE INTEGRATED SPRING MECHANISM ON THE ROLLER, THE SASH IS ALMOST DRAWN TOWARDS THE FRAME BY ITSELF WHEN IT IS CLOSED.

LUXURY OPERATING CONVENIENCE

Spring mechanism and damper

The sash can be closed with very little tractive or pressure force. This ease of operation is thanks to the integrated spring mechanism in the roller and the damper on the scissor stay. The spring assembly in the mechanism stores the energy applied when opening the door and is thereby tensioned. When the sash is closed, the energy stored is released once again. As a result, the hardware pulls the sash towards the frame as if it is acting by itself.

LONG-TERM QUIET RUNNING

Roller incl. cleaning brushes

Integrated cleaning brushes before each roller prevent dirt from entering the rollers. This ensures long-term smooth running and an extremely convenient sliding operation.

DIRT DOESN'T STAND A CHANCE
 INTEGRATED CLEANING BRUSHES MAKE A SIGNIFICANT CONTRIBUTION TO THE LONG-TERM SMOOTH RUNNING OF THE ROLLERS.



FLEXIBILITY FOR ENERGY EFFICIENCY

Scissor stays and roller

Sash stop widths of 125 mm and a load capacity up to 200 kg means that even very thick sash profiles can be implemented, such as those used for passive and zero-energy houses.

FAIL-SAFE OPERATION

We guide the opening of the unit and assist with closing

The unit can be intuitively operated like a turn&tilt window: if the window is closed, the handle points downwards. Turn the handle 90 degrees to its horizontal position to open the unit. For parallel stop, simply turn the handle 180 degrees vertically upwards – as you would to tilt a window. Anyone can operate the window with ease.

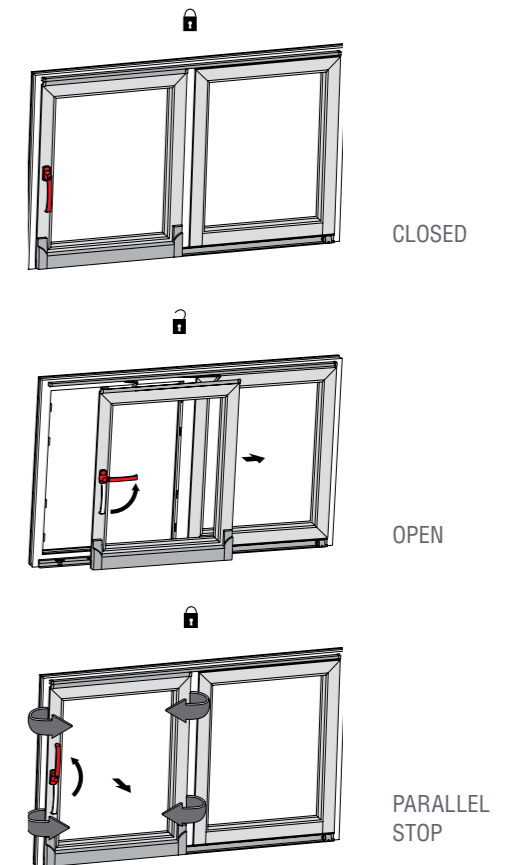



ALMOST ONE LEVEL
THE LOW TRANSIT-PERSONAL-THRESHOLD MAKES FOR A COMFORTABLE TRANSITION BETWEEN THE INDOOR AREA AND THE PATIO OR BALCONY.

EASY ADJUSTMENT

Adjusted threshold structure

Opt for the TRANSIT-PERSONAL threshold, to make the transition between indoors and outdoors even more comfortable. Thanks to the low frame clearance of 35 mm and the low threshold height, it is suitable for a level passageway on timber and timber/aluminium profile systems. The non-slip nature of the threshold also provides considerable user comfort.

HEALTHY INDOOR CLIMATE

Parallel stop

For all-round ventilation in the parallel stop, the sash is stopped at a width of 5 mm. This position allows the exchange of draught-free air. The advantage? The room does not cool down abruptly.



SECURE VENTILATION

Parallel stop

Ventilation without the risk of a burglary? Security class RC 2 is also guaranteed with the parallel stop. And what's more: since the parallel stop is barely visible from the outside, potential thieves will not even notice this access route into the house. The i.S. security roller cams themselves, which are fitted as standard, reliably prevent burglary attempts.

FIRMLY LOCKED

Handles

The slide&tilt handle is available as a standard version or as a lockable version with key. Available in five colours, it provides the perfect finishing touch to the PAS hardware.



STANDARD-COMPLIANT CONNECTION OF FLOOR-DEPTH UNITS

THE FIRST SOLUTION TO THE BUILDING CONNECTION PROBLEM

When it comes to floor-depth units, building caulkers complain that there are not enough connection options: the biggest challenge is properly sealing floor-depth large-format units over the long term. This is because the majority of building seals cannot be adequately applied to the unit.

Of course, you know that it is more important, and more complicated than ever to perfectly plan standard-compliant building connections. With balconies, flat roofs and terraces, in particular, you are faced with numerous requirements.

A RUDE AWAKENING

If the end customer has to contend with water damage or even with resulting mould, then the question is: who takes responsibility? A range of tradespeople are involved in the installation of floor-depth units, often making it hard to determine who is really at fault.

AN END TO THE BUILDING CONNECTION PROBLEM
THE MACO INSTALLATION SOLUTION FOR
CONNECTING FLOOR-DEPTH UNITS OPTIMALLY
FULFILS COMMON STANDARDS.

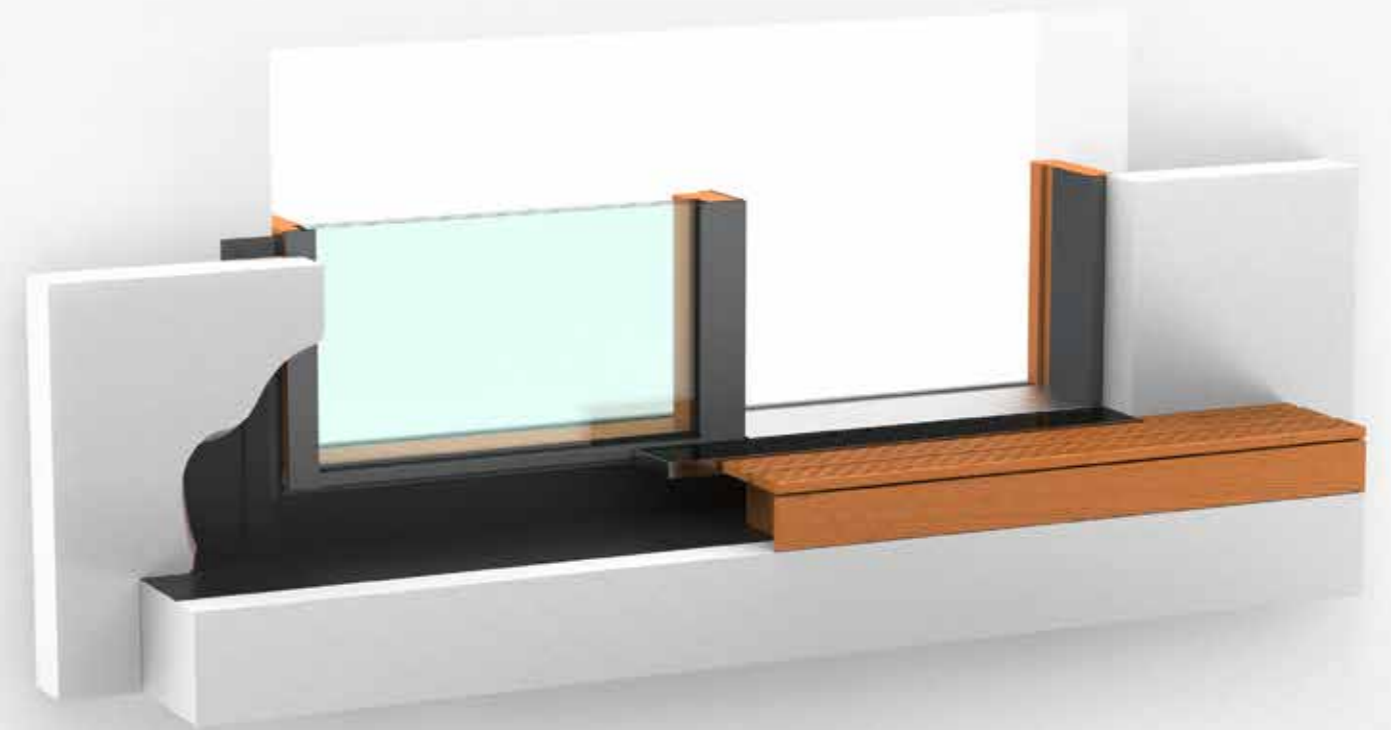

MACO SAVES YOU WORK

MACO is aware of this problem. Our aim is to not only provide you with high-quality products, but also to offer comprehensive services and to strengthen your competitive position with complete solutions. Therefore, together with building caulkers, window fitters and experts, MACO has developed an installation solution for the connection of floor-depth units using MACO thresholds. This optimally complies with common standards in Germany, Austria and Switzerland.

A FOCUS ON THE ENTIRE SYSTEM

To do so, the entire installation process was analysed, the various requirements of each trade were taken into account, reconciled and converted into easy-to-understand assembly instructions. A newly-developed component will help you to install windows and lift&slide units into building shells in a manner that complies with standards. These meet all the requirements for wind and construction phase impermeability.

EXTERNALLY EXAMINED

Another advantage: not only has the connection solution been tested by MACO, it has also been tested by external experts and it has been verified that it complies with standards. This means you can rest assured that the building caulkers can carry out their work without any issues and create a watertight finish. And your customers can feel confident that their casement doors and sliding units will be tightly sealed for years to come.

TECHNOLOGY IN MOTION



Publishing Details

Publisher: MAYER & CO BESCHLÄGE GMBH

UID-Nr. ATU39042709 · Landesgericht Salzburg FN 136280 m · Finanzamt Salzburg-Stadt · St. Nr. 116/6122 · DVR 0564389

Management board: DI Ernst Mayer, Guido Felix, Ewald Marschallinger, Jürgen Pratschke, Ulrich Wagner

This publication is intellectual property of MAYER & CO BESCHLÄGE GMBH.

Editorial board: Marketing MACO group · Layout and composition: www.fredmansky.at

Photo credits: MACO, Fotolia, picture archive Fredmansky · Print: Gutenberg-Werbering Gesellschaft m.b.H. Linz

Order number 757256EN · February 2016 · published in Salzburg

Subject to alterations. All rights reserved.